



SOAP BOX DERBY®



Super Stock Car Plans

A comprehensive guide to help you build an official Soap Box Derby® Super Stock Car
Updated August, 2017

For a comprehensive video to help you build a Super Stock Car please visit

<https://www.youtube.com/aasbdorg>



Table Of

Introduction.....	Page 3
General Assembly Guidelines.....	Page 4
Help, Guidance & Support.....	Page 4
Supplies & Tools.....	Page 5
Super Stock Floorboard.....	Page 6
Step One Steering Stop Installation	Page 7
Step Two Foot Brace Installation	Page 8
Step Three Kingpin/Stabilizer Bushing Installation	Page 9
Step Four Steering Hardware Installation.....	Page 13
Step Five Steering Cable Installation.....	Page 16
Step Six Angle Iron Installation	Page 21
Step Seven Brake Pad Installation	Page 23
Step Eight Brake Installation	Page 24
Step Nine Weight Bolt Installation.....	Page 29
Step Ten Airfoil Installation.....	Page 31
Step Eleven Axle Alignment & Triangulation.....	Page 33
Step Twelve Shell Installation.....	Page 35
Step Thirteen Signage, Lettering & Decoration	Page 37
Step Fourteen Wheel Kit Installation.....	Page 38
Step Fifteen Assembly Checklist.....	Page 39
Tech Tip #1 - Optional Weights	Page 40
Tech Tip #2 - Optional Finishes	Page 43
Tech Tip #3 - Cockpit Foam	Page 44
Tech Tip #4 - Alignment.	Page 46

For a comprehensive video to help you build a Super Stock Car please visit
<https://www.youtube.com/aasbdorg>



Introduction

Welcome to Soap Box Derby® racing! The Soap Box Derby program is designed to be an enjoyable learning experience for both the adult and the child. The program provides an opportunity to develop mutual respect and trust while demonstrating the importance of individual pride and sportsmanship.

The Super Stock Car is a sit-up car designed to be driven in a lean forward position at all times for builders of a specific age range (9-18). The combined weight of the assembled car and the driver shall not exceed 240 lbs. including the Z-Glas® wheels. A combined weight of less than 240 lbs. may be increased by the addition of owner provided weight.

The written rules, plans and regulations are designed for the participant to construct the car from a Super Stock Car kit purchased from the International Soap Box Derby, Inc. For rules and regulations, including eligibility and age range information, see the "Rule Book" available from the International Soap Box Derby, Inc. at soapboxderby.org. The established rules, plans and regulations shall be applicable to all races and events and shall be taken into account as to all issues involving the construction of a car. By participating in these events, all participants are deemed to have consented to the rules and authority of person who shall enforce the rules.

No expressed or implied warranties of any kind, including any warranty of safety, shall result from the publication or compliance with these rules, plans and regulations. In no event shall the International Soap Box Derby, Inc. be liable for any loss, indirect, special, or consequential damages even if the International Soap Box Derby Inc. has notice of possibility of such damages. The International Soap Box Derby, Inc. makes no warranties, including any warranties of fitness for a particular purpose with respect to the publication or compliance with these rules, plans or regulations. In all situations, the rules and regulations promulgated by the International Soap Box Derby, Inc. shall govern and control over any conflicting provision in these plans.

Each participant understands and agrees that a prerequisite to competing in any championship race sanctioned by the International Soap Box Derby Inc. in Akron, Ohio, that the racer and his or her car shall undergo, and pass inspection conducted at Akron, Ohio by the International Soap Box Derby Inc. Each participant further understands and agrees that such inspection shall be conducted using the manner and methods deemed appropriate by the International Soap Box Derby Inc. in its sole discretion to determine compliance with the rules, plans, regulations, spirit of the rules and specifications applicable to that division and that the decisions of the International Soap Box Derby Inc. and its officials regarding qualifications and disqualification in compliance with the rules, spirit, plans, regulations and specifications applicable to that division shall be final and binding upon all parties.

This guide contains proprietary information of the International Soap Box Derby (ISBD). It is intended solely for the information and use of parties building a Soap Box Derby® Super Stock Car. Such proprietary information may not be used, reproduced, or disclosed to any other parties for any other purpose without the expressed written permission of ISBD.

General Assembly Guidelines

A parent, guardian or mentor is expected to help in the construction of the car. The parent, guardian or mentor must not build the car for the child, but instead share this educational experience by being present and giving help only when and if necessary.

This plan booklet shall be followed when assembling your car. The hardware provided in the International Soap Box Derby, Inc. Super Stock Car kit must be used and assembled as shown in the latest rules, plans and specifications. No changes, modifications, or additions, other than the inclusion or omission of specified optional parts, shall be made to the car. All new and existing Super Stock Cars shall be updated to the latest set of rules and plans for the Super Stock division.

Replacement of all hardware, as well as optional parts, is available from the International Soap Box Derby, Inc. In general, replacement parts are sold in bags specified for each installation step of the car's construction and optional parts are available on a per item basis.

Altering, modifying or tampering with the floorboard, shell, or any other hardware is prohibited and means for disqualification. Changes, alterations, modifications and/or replacements not authorized by the plans and/or rules should NOT be assumed to be legal under the "Spirit of the Rules."

Help, Guidance & Support

Questions or inquiries for clarification pertaining to the rules, plans and/or regulations shall be directed primarily to your Local Race Director and/or Regional Director. The International Soap Box Derby, Inc. also offers a web site at www.soapboxderby.org that provides additional assistance to the parent, guardian, mentor and/or child. The website contains links to useful information such as the latest rules and plans, ordering kits or parts online, Local Race city organization contact information and frequently asked questions to name a few.

If further explanation is needed, questions should be directed to the International Soap Box Derby, Inc. All questions or inquiries for clarification must be emailed to raceprograms@soapboxderby.org.

Please note that a response to a specific participant's question may not apply to all other participants.



Supplies And Tools

The following items are needed in the basic assembly of the Super Stock Car. The International Soap Box Derby, Inc. does not provide these tools as part of the kit. Sources for these tools include, but are not limited to, hardware and automotive supply stores.

1. Screwdrivers
 - #2 Phillips screwdriver
 - Wide flat blade screwdriver
2. Wrenches or Sockets
 - 3/8" open-end box wrench
 - 7/16" open-end box wrench
 - 1/2" open-end box wrench
 - 11/32" open-end box wrench
3. Pliers
 - Standard Pliers
 - Wire Cutter Pliers
4. Allen Wrench
 - 5/64" Allen Wrench
5. Measuring Tape
 - 10' minimum length
6. Hammer
 - Standard Hammer or Mallet
7. Contact Cement
8. Masking Tape
9. Electrical Tape
10. Hacksaw

The following items are OPTIONAL to aid in the assembly and basic finish of the Super Stock Car. The International Soap Box Derby, Inc. does not provide these tools or supplies as part of the kit. Sources for these tools include, but are not limited to, hardware and automotive supply stores.

1. Metal Cleaning Materials
 - Steel wool
 - Non-metallic abrasive pad
2. Finishing
 - Automotive wax
 - Paint (see tech tips on optional finishes)
3. Soldering Iron with lead-free solder and flux (optional)
4. Support Boards (optional)(2)
2 x 4 x 18"
5. Feeler Gauges (optional)
6. "C" Clamps (optional)
7. Battery Powered Drill (optional)
8. Tung Oil (optional)



Super Stock Floorboard Legend

Below is the **Super Stock floorboard legend**. This diagram will give you a brief overview of some of the steps in the assembly process. Each step listed on this page will be explored in greater detail in upcoming steps. All Super Stock floorboards engraved with the Derby shield or burned with the SBD or SBD shield brands are the only acceptable floorboards. The logo side of the floorboard is the top. Tung oil and wax are the only acceptable products that may be applied to the floorboard. Tung Oil such as Minwax and Formby's are available on the open market. The Tung Oil and wax may be used on all surfaces of the floorboard. Please note that the machine marks on the sides of the floorboard shall remain. No finish build-up thickness shall occur.

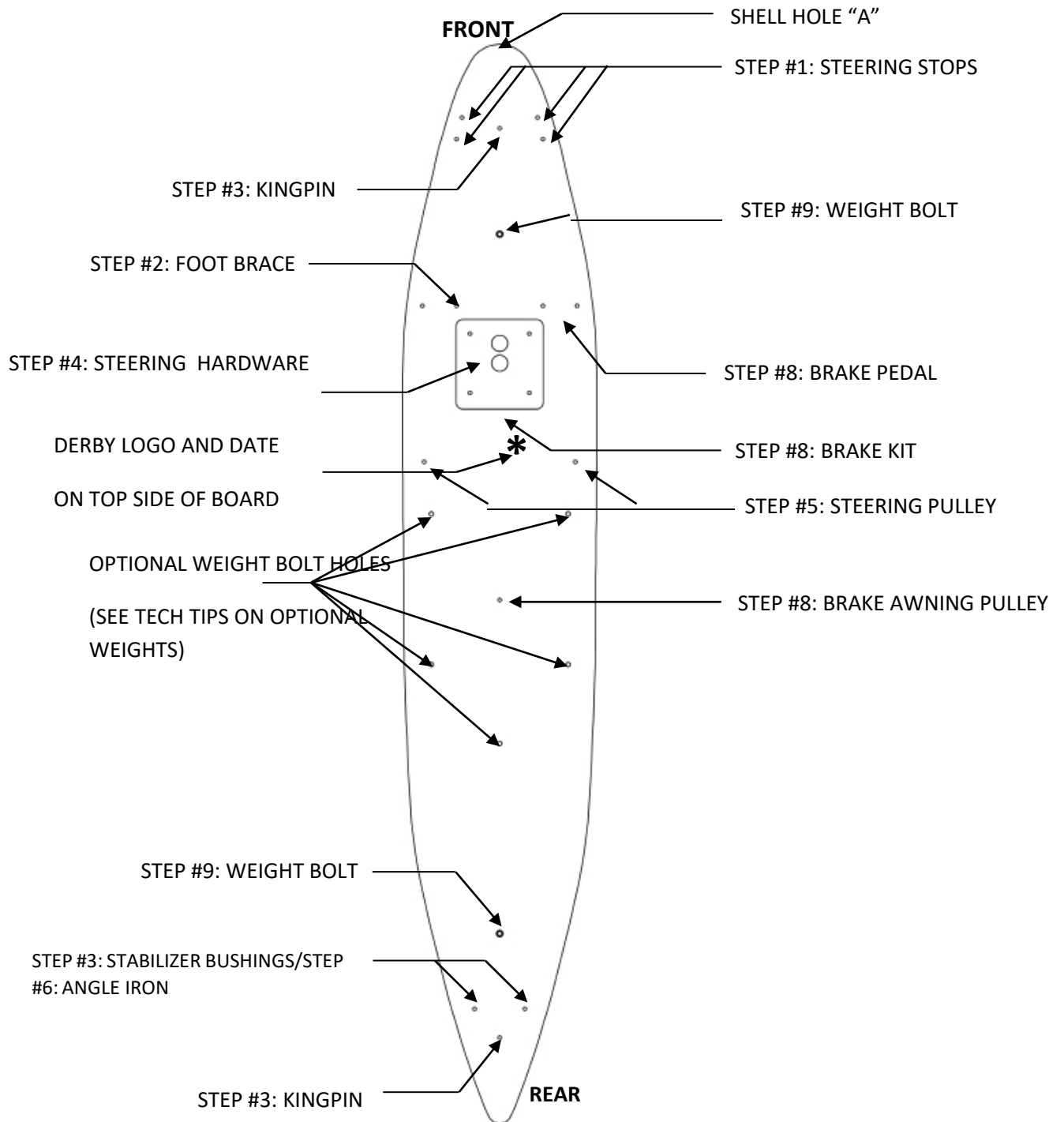

Step One

Steering Stop Installation. Required Items: Steering Stop Bag, Floorboard, Tools

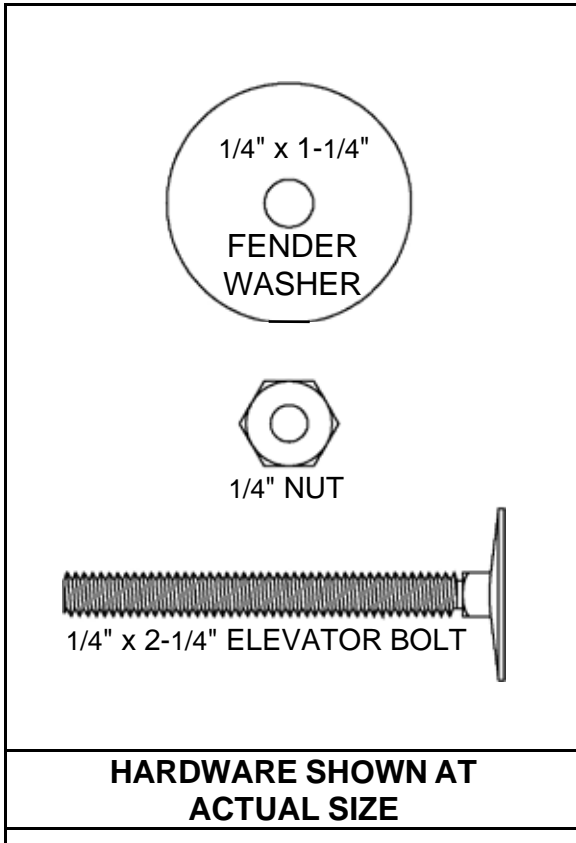

**Steering Stop
(Legend Area Highlighted)
Steering Stop Installation**

- 1.1 Insert one 1/4" x 2-1/4" elevator bolt through the floorboard bottom at a steering stop hole location and pressthrough the floorboard. See legend for location of holes.
- 1.2 Place a 1/4" x 1-1/4" fender washer on the elevator bolt on top of the floorboard.
- 1.3 Install 1/4" nut on 1/4" x 1-1/4" fender washer. Tighten nut until elevator bolt is drawn in flush with bottom of floorboard. Install two additional 1/4" nuts for a total of three. See Photo # 1.3. NOTE: Elevator bolts may only be pulled flush by normal tightening of the bolt. The floorboard may not be cut or drilled to accept the elevator bolthead
- 1.4 Repeat Steps 1.1 through 1.3 for the other three steeringstop locations. See Photo # 1.4

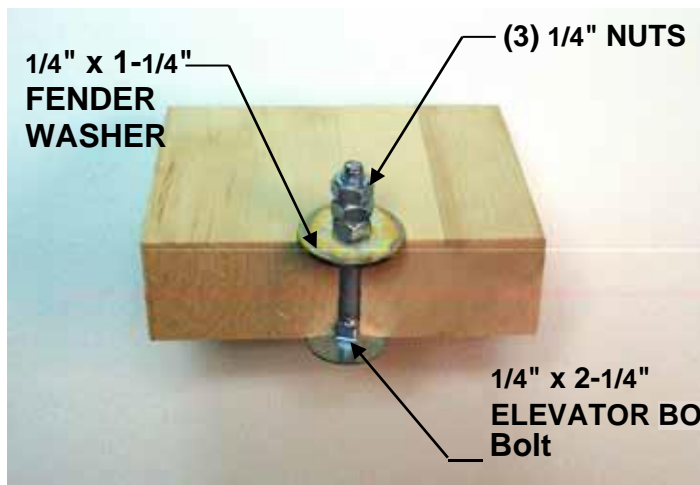

Photo #1.3



Photo #1.4

Step Two

Foot Brace Installation. Required Items: Foot Brace Bag, Floorboard, Foot Brace, Tools

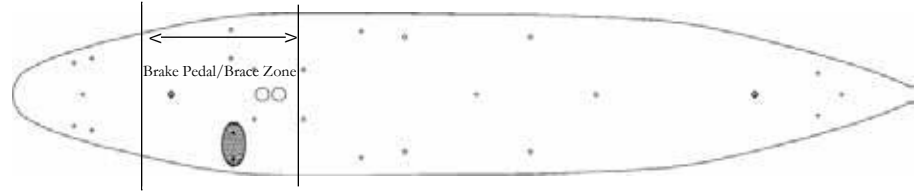
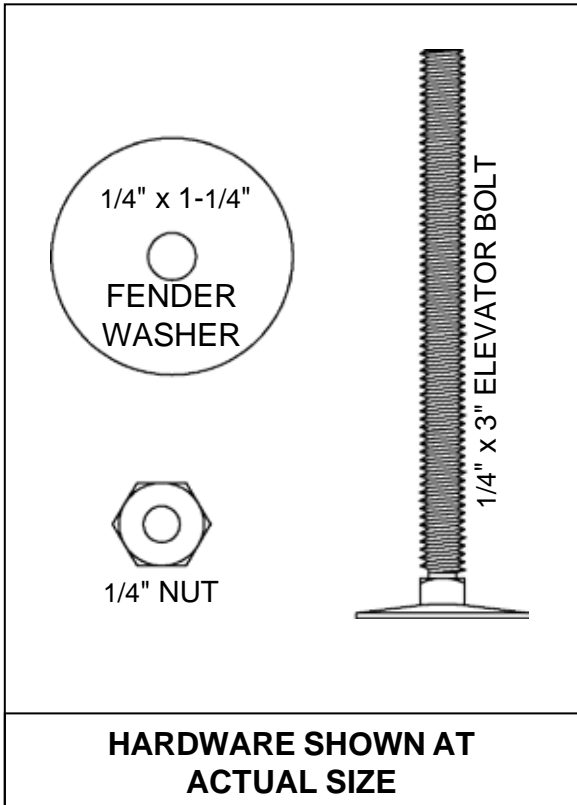

Foot Brace

Foot Brace Installation

Brake pedal and foot brace may be moved forward or back in brakePedal/Brace Zone to accommodate a driver.

- 2.1 Insert two 1/4" x 3" elevator bolts through the floorboard bottom at a foot brace hole location and press through the floorboard. See legend for location of holes.
- 2.2 Install 1/4" x 1-1/4" fender washer on elevator bolt along with a nut and draw flush with floorboard. Take off washer and nut.
- 2.3 Place foot brace on the elevator bolt.
- 2.4 Place a 1/4" x 1-1/4" fender washer on the elevator bolt on top of the foot brace.
- 2.5 Install 1/4" nut on 1/4" x 1-1/4" fender washer. See Photo# 2.5.

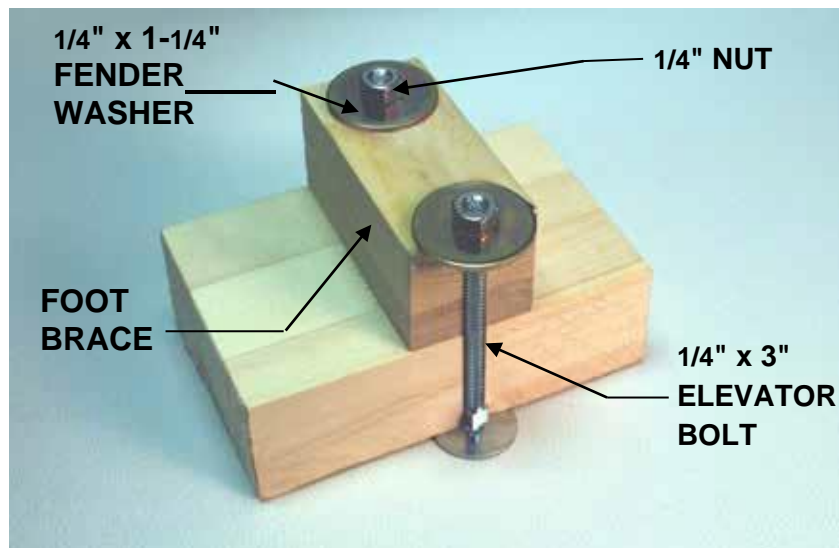
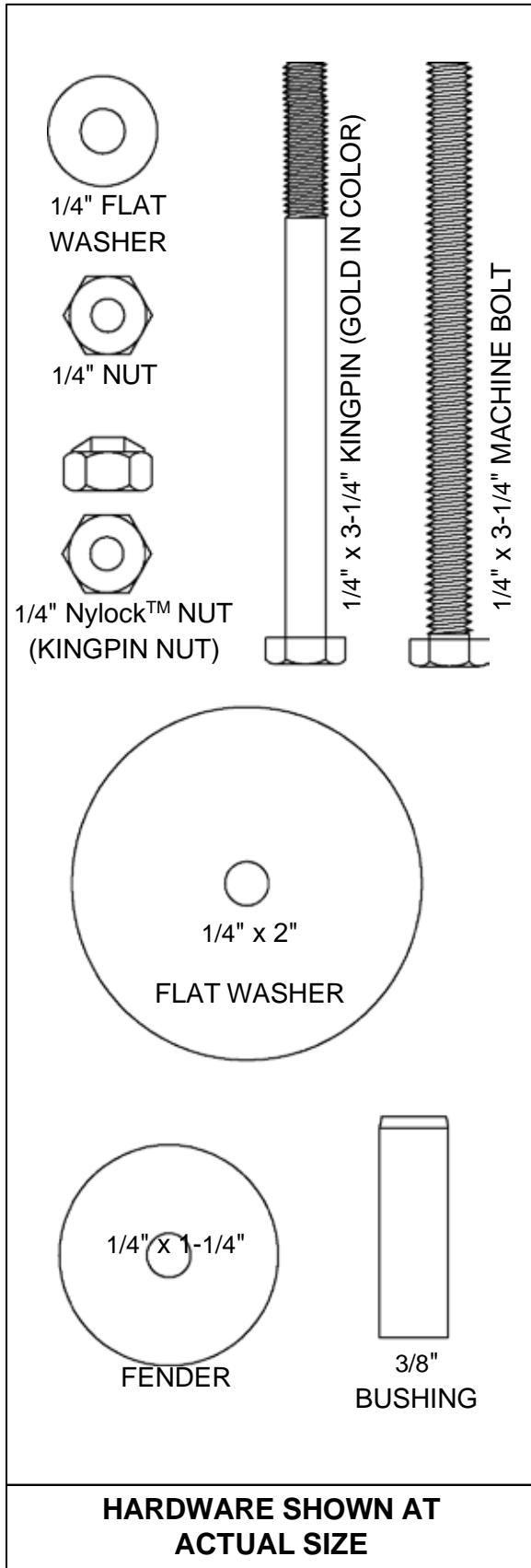

Photo #2.5

Step Three

Kingpin Installation/Stabilizer Bushing Sub-Assembly. Required Items: Kingpin Bag, Floorboard, Set of Axles, SS Rear Axle Plate, Tools



Kingpin Bushing Installation (Legend Area Highlighted)

Bushing Installation Sub-Assembly

Kingpin bushings and stabilizer bushings may be adhered to the floorboard using epoxy (provided by others). A limited amount of epoxy is acceptable. Floating of bushings in floorboard is non-acceptable. There is no epoxy permitted on the kingpin. The kingpin must turn freely in the bushing.

- 3.1 Place 1/4" x 1-1/4" fender washer on 1/4" x 3-1/4" machine bolt. **Bolt is silver in color.**
- 3.2 Place bushing with flat end against fender washer on the 1/4" x 3-1/4" machine bolt.
- 3.3 Insert assembly through the top of floorboard with beveled end of bushing against floorboard until bolt extends through opposite side of floorboard at kingpin location. See legend for location of holes.
- 3.4 Place a 1/4" x 1-1/4" fender washer on the machine bolt against the floorboard.

TOP OF FLOORBOARD

1/4" x 1-1/4" FENDER WASHER

3/8" BUSHING

Photo # 3.5

1/4" x 1-1/4" FENDER WASHER

1/4" NUT

1/4" x 3-1/4" MACHINE BOLT

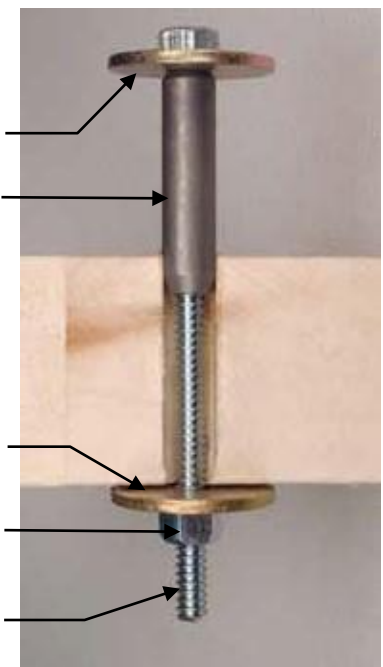

Step Three Continued

Kingpin Bushing Installation Sub-Assembly Continued

- 3.5 Install a 1/4" nut on 1/4" x 31-1/4" machine bolt. See Photo # 3.5
- 3.6 Tighten machine bolt assembly until bushing ends are flush with floorboard.
- 3.7 Remove 1/4" nut from 1/4" x 3-1/4" machine bolt and 1/4" x 1-1/4" fender washers. See Photo # 3.7
- 3.8 Repeat steps 3.1 through 3.7 for second kingpin bushing location.

Stabilizer Bushing Sub-Assembly

- 3.9 Repeat steps 3.1 through 3.7 for Stabilizer Bushing (see legend below for hole locations)

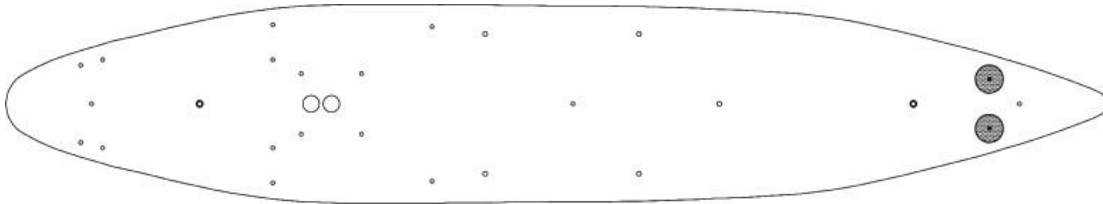

- 3.10 Epoxy may be used to secure the bushings in the floorboard. The expected way is to coat the inside of the hole in the floorboard with epoxy and then install the bushing before the epoxy dries.
- 3.11 Floating of the bushing by drilling an oversize hole and permitting the epoxy to fill the void is not acceptable.

- NOTE: All floorboards require an AASBD branding or engraved shield. The following floorboard dimensions must be met.
1. Front kingpin dimension of 5-13/16" is a maximum value measured from the front center of floorboard to the center of the front kingpin.
 2. Wheelbase is 63-3/8" +/- 1/16". From center of front kingpin to the center of rear kingpin.

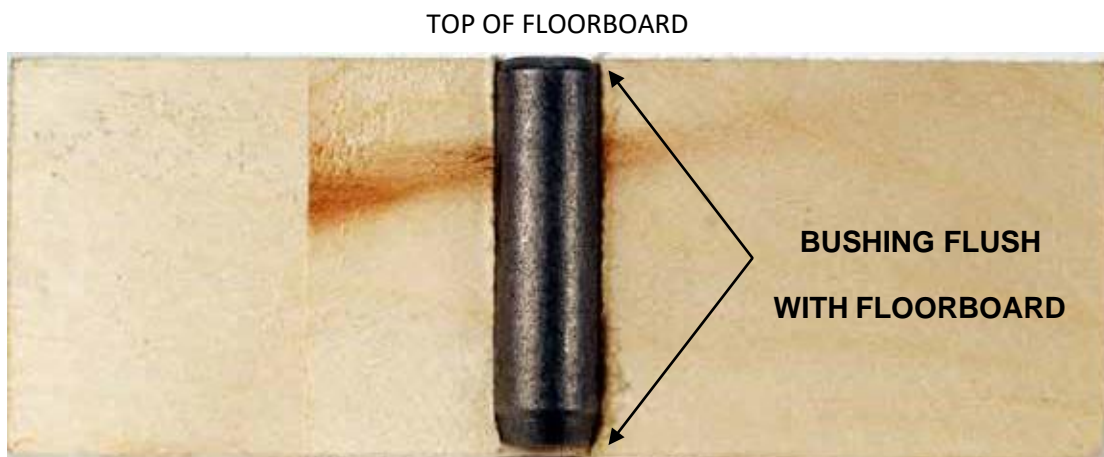

Photo #3.7

Step Three

Continued

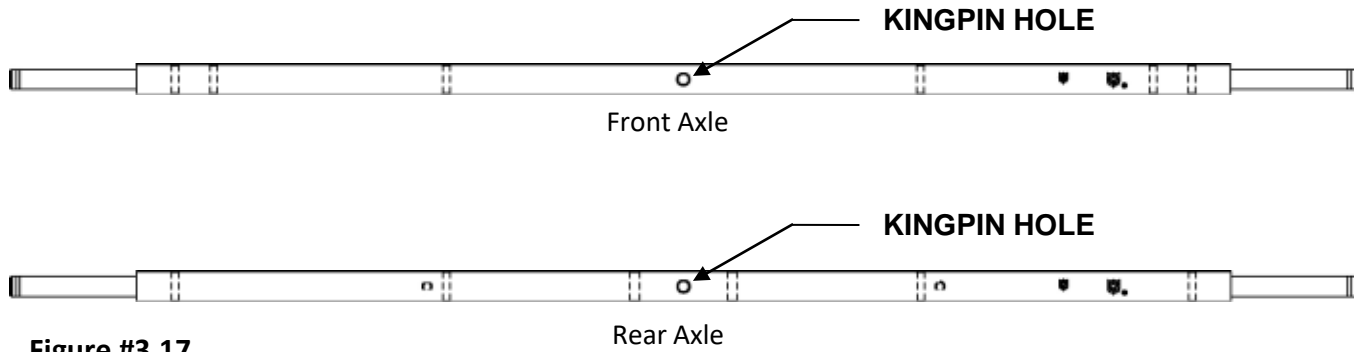
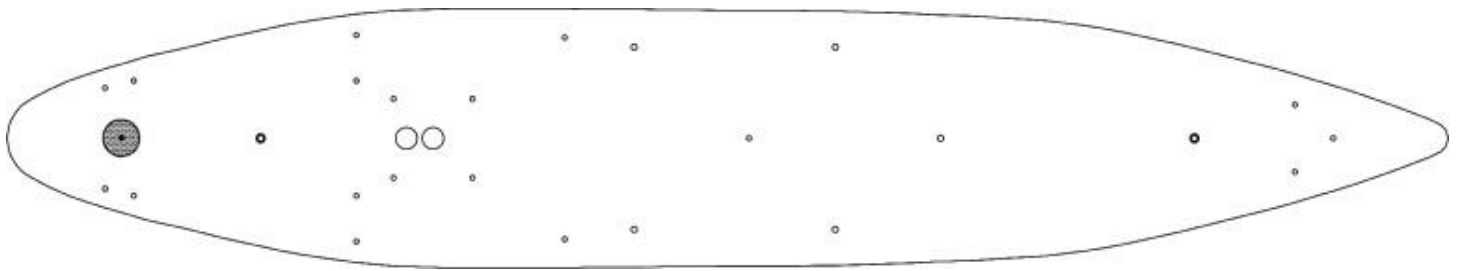

Figure #3.17



Front Kingpin Sub-Assembly
(Legend Area Highlighted)

- 3.12 Place a 1/4" x 2" flat washer on 1/4" x 3-1/4" kingpin. Kingpin bolt is gold in color.
- 3.13 Insert kingpin/washer assembly through the bottom of floorboard at front axle location and press through floorboard. See legend for location of hole.
- 3.14 Place 1/4" x 2" flat washer on 1/4" x 3-1/4" kingpin.
- 3.15 Place 1/4" x 1-1/4" fender washer on kingpin.
- 3.16 Place 1/4" flat washer on kingpin.
- 3.17 Place front axle on kingpin. See Figure # 3.17 for front axle identification.
- 3.18 Place two 1/4" flat washers on top of the axle.
- 3.19 Install two 1/4" Nylock™ nuts (kingpin nut). Tighten kingpin assembly. See Photo # 3.19

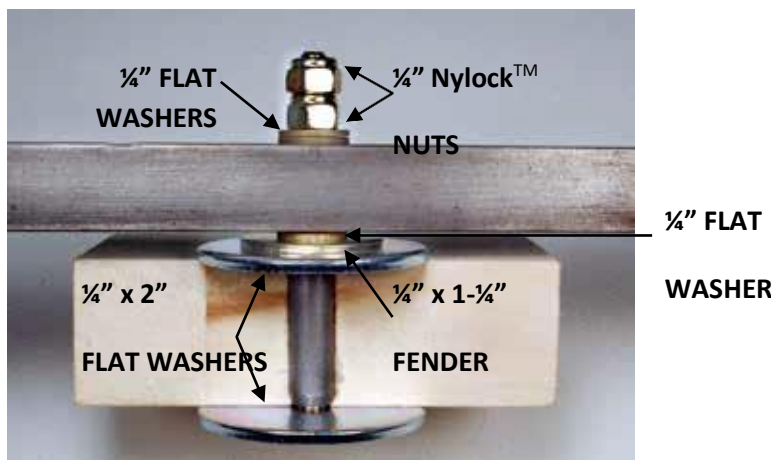

Photo #3.19 (Front Kingpin Washer Stack)

Step Three Continued

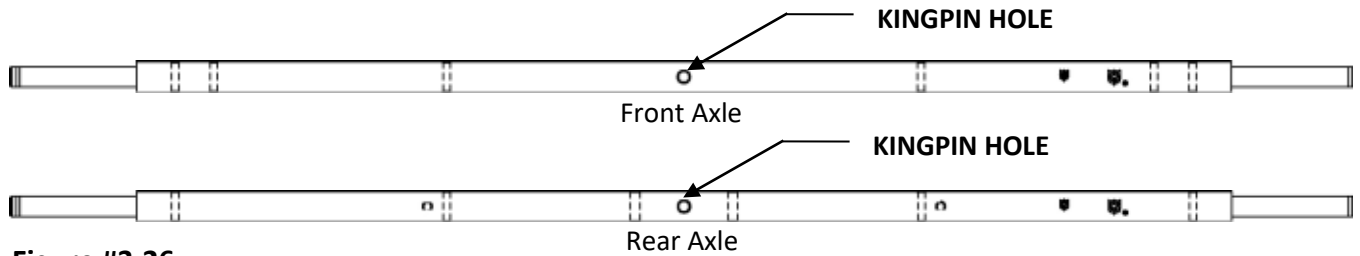
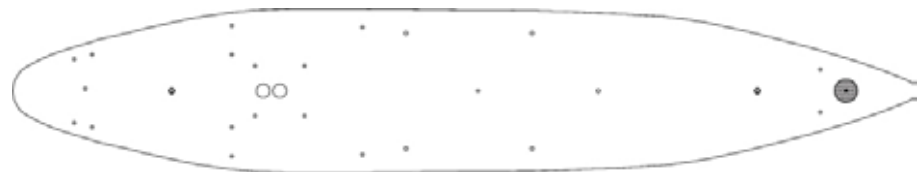

Figure #3.26



Kingpins Installation (Legend Area Highlighted) Rear Kingpin Sub-Assembly

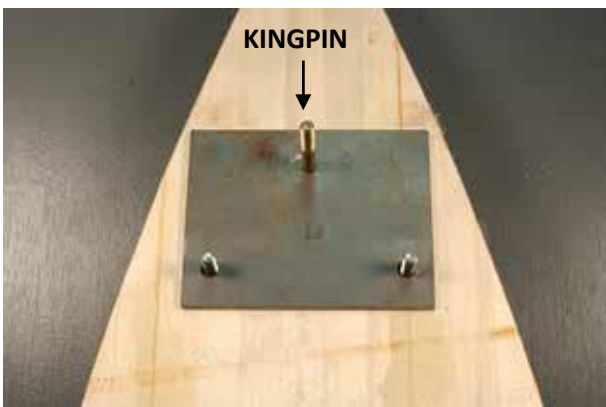

Photo #3.22

(Bolts other than the kingpin are not part of this step; they are shown for clarity only.)

- 3.20 Place a 1/4" x 2" flat washer on 1/4" x 3-1/4" kingpin. Kingpinbolt is gold in color.
- 3.21 Insert kingpin/washer assembly through the bottom of floorboard at rear axle location and press through floorboard. See floorboard legend for location of hole.
- 3.22 Place SS Rear Axle Plate on 1/4" x 3-1/4" kingpin. Align holes in SS Rear Axle Plate with those in the floorboard. See Photo # 3.22
- 3.23 Place 1/4" x 2" flat washer on 1/4" x 3-1/4" kingpin (on top of the SS Rear Axle Plate).
- 3.24 Place 1/4" x 1-1/4" fender washer on kingpin.
- 3.25 Place 1/4" flat washer on 1/4" x 1-1/4" kingpin.
- 3.26 Place rear axle on kingpin. See Figure # 3.26 for rear axle identification.
- 3.27 Place two 1/4" flat washers on top of the axle.
- 3.28 Install one 1/4" Nylock™ nut (kingpin nut). See Photo #3.26. **Do not completely tighten kingpin assembly.** Further adjustments to occur in future Step 11.

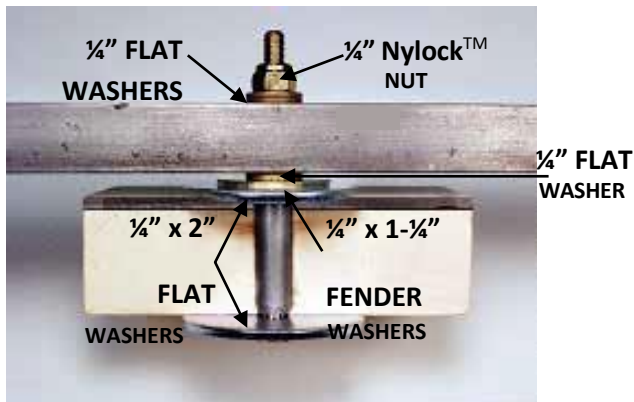

Photo # 3.26

(Rear Kingpin Washer Stack)

Step Four

Steering Hardware Installation. Required Items: Steering Bag, Floorboard, Brake/Steering Mount, Steering Wheel, Tools

1/4" x 2-1/4" ELEVATOR BOLT

1/4" x 2" ELEVATOR BOLT

3/32" x 1-3/4" COTTER PIN

1/4" LOCK WASHER

1/4" NUT

CABLE PULLEY

1/4" FLAT WASHER

3/4" I.D. FLAT WASHER

HARDWARE SHOWN AT ACTUAL SIZE



**Brake/Steering Mount
(Legend Area
Highlighted)**

Brake/Steering Mount Sub-Assembly

Brake/steering mount may be moved forward only to accommodate a driver.

- 4.1 Insert a quarter or washer (provided by others) into the recessed floorboard area where the steering wheel shaft is to be installed. See Photo # 4.1



Photo #4.1

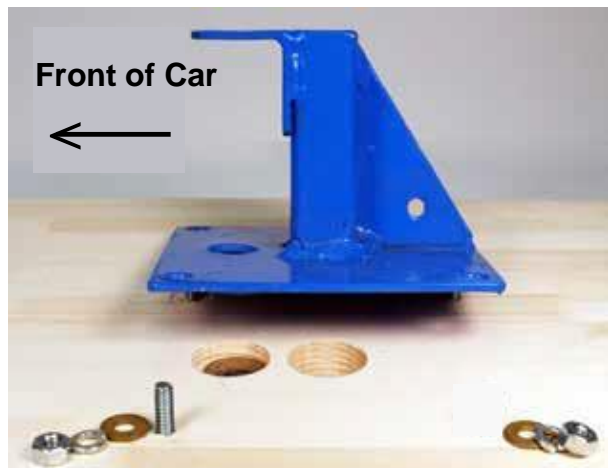

**Photo #4.3
Brake/Steering Mount
Bolts Shown For Alignment Only**

Step Four

Continued

4.2 Insert one 1/4" x 2" elevator bolt through the floorboard bottom at front brake/steering mount hole location and pressthrough the floorboard. See floorboard legend for location of hole. Install 1/4" flat washer and 1/4" nut on bolt and draw bolt flush with bottom of floorboard. Remove nuts and washers. Repeat for the second front hole location.

4.3 Place brake/steering mount on top of 1/4" x 2" elevator bolts. See Photo #4.3

4.4 Place 1/4" flat washer on the 1/4" x 2" elevator bolts on top of brake/steering mount.

4.5 Place 1/4" lock washer on the 1/4" x 2" elevator bolts on top of the brake/steering mount.

4.6 Install 1/4" nut on bolts. See Photo # 4.6. **Do not completely tighten nut.**

4.7 Insert one 1/4" x 2-1/4" elevator bolt through the floorboard bottom at rear brake/steering mount hole location and pressthrough the floorboard. Install 1/4" flat washer and 1/4" nut on bolt and draw bolt flush with bottom of floorboard. Remove nut.

4.8 Place cable pulley on the 1/4" x 2-1/4" elevator bolt on top of brake/steering mount.

4.9 Place 1/4" lock washer on top of the cable pulley.

4.10 Install 1/4" nut on 2-1/4" elevator bolt. See Photo # 4.10 (a) & Photo # 4.10(b). **Do not completely tighten.**

4.11 Repeat Steps 4.7 through 4.10 for second rear brake/steering bolt location.

Steering Wheel Sub-Assembly

4.12 Tighten all four nuts. Insert brake plunger through floorboard and brake/steering mount to check for proper alignment.

4.13 Insert steering wheel shaft through the round hole on the brake/steering mount (**steering wheel bow tie may face in either direction**).

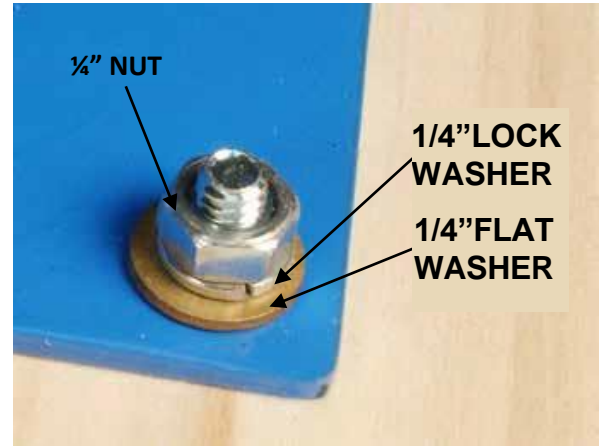

Photo #4.6

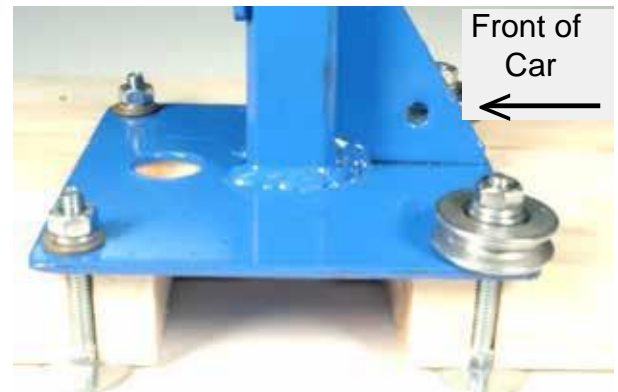

Photo #4.10(a)

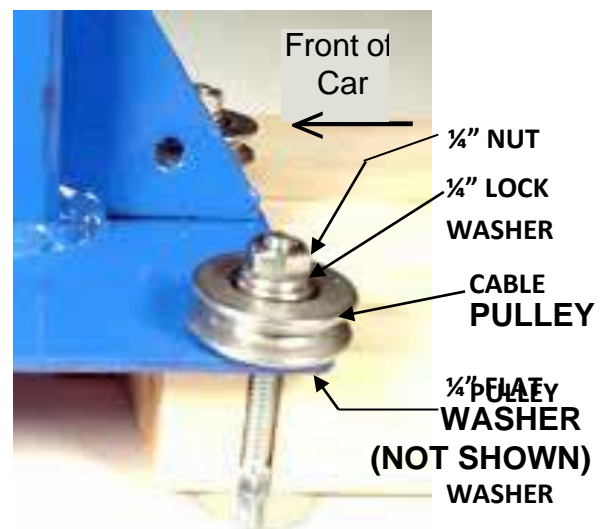

Photo #4.10(b)



Step Four

Continued

- 4.14 Raise the steering wheel and slide the 3/4" I.D. flat washer on to the bottom of steering wheel shaft.
- 4.15 Push steering wheel down through brake/steering mount hole until shaft rests on top of quarter or washer installed in Step 4.1.
- 4.16 Push the 3/4" I.D. flat washer up against the brake/steering mount and insert 3/32" x 1-3/4" cotter-pin through the upper steering wheel shaft hole. See Photo # 4.16
- 4.17 Bend end of cotter pin around steering wheel shaft.

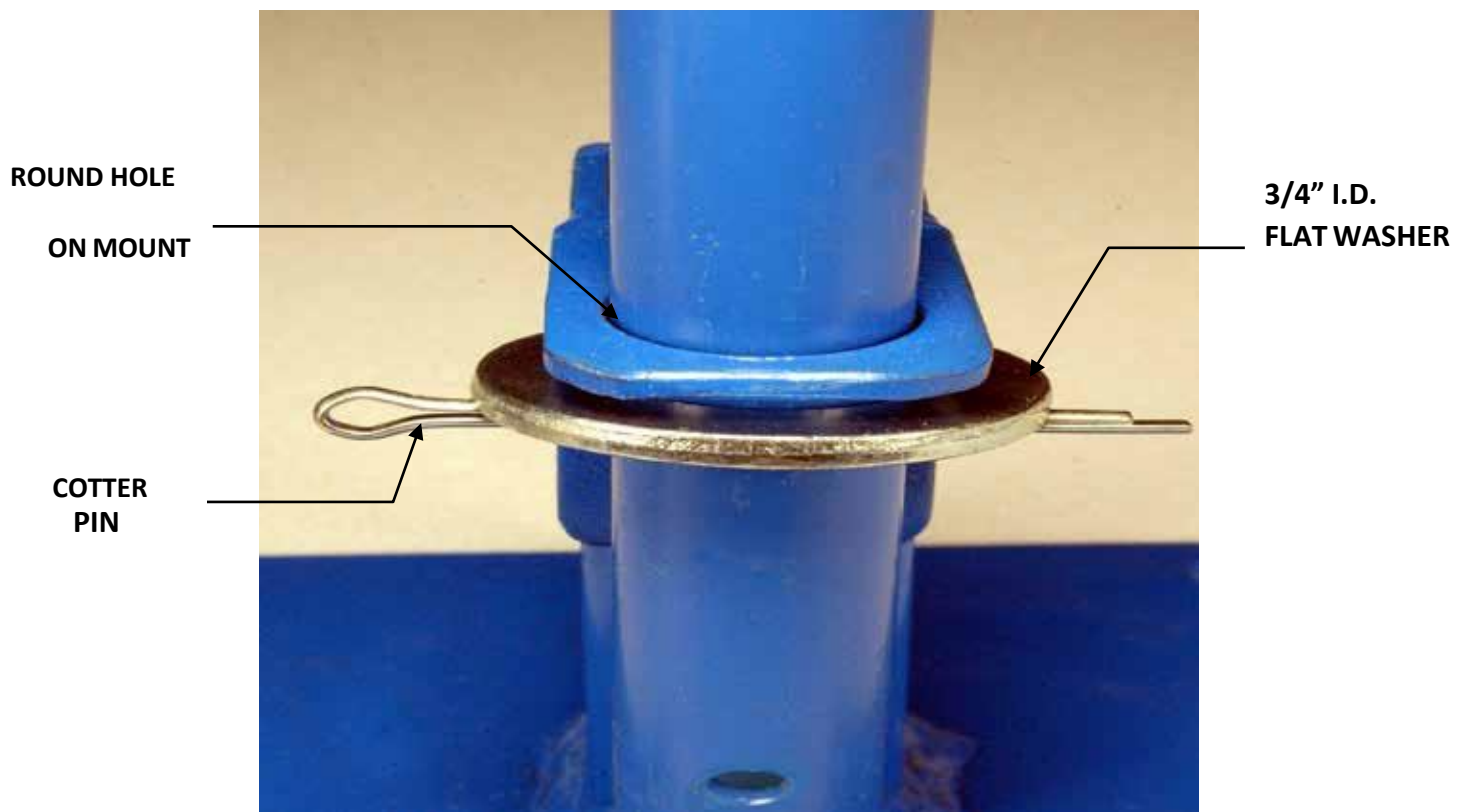
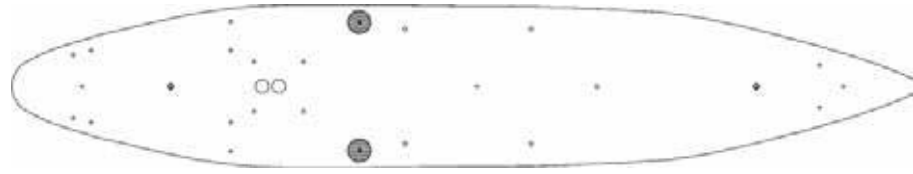
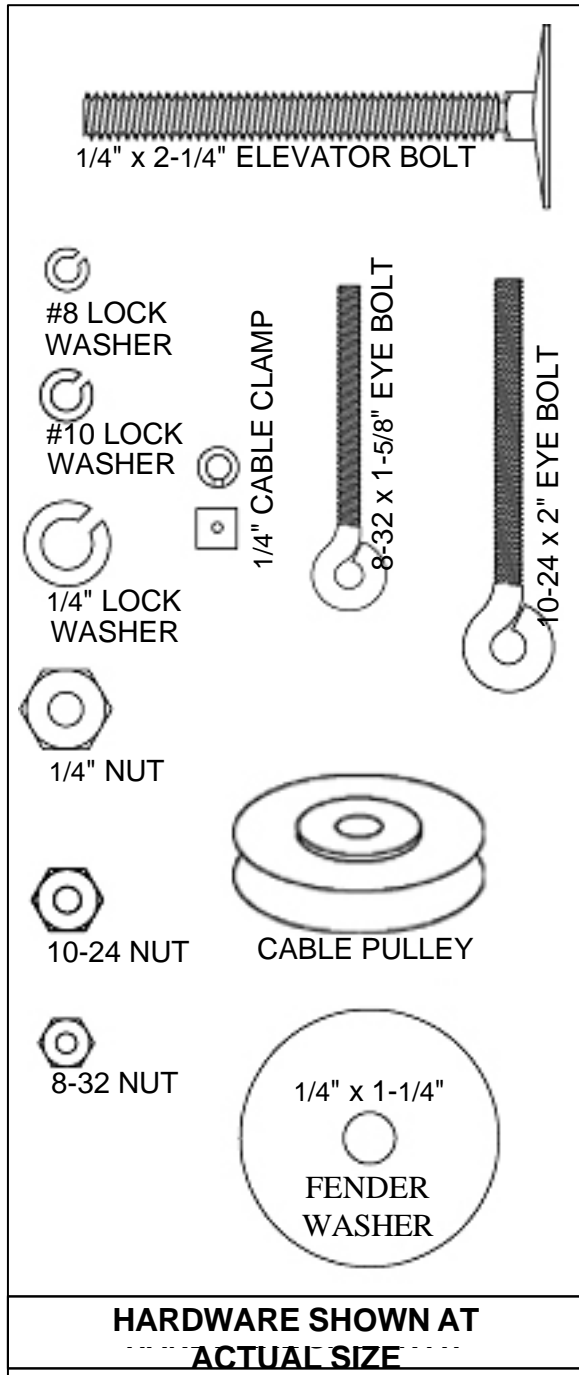

Photo #4.16

NOTE: Brake/steering mount may be moved forward only to accommodate a driver.

Step Five

Steering Cable Installation. Required Items: Steering Cable Bag (complete with Steering Cable and Cable Adjuster), Floorboard, Steering Cable, Tools



Cable Pulley Sub-Assembly (Legend Area Highlighted)

- 5.1 Insert one 1/4" x 2-1/4" elevator bolt through the floorboard bottom at a steering cable pulley hole location and press through the floorboard. See legend for location of holes.
- 5.2 Place a 1/4" x 1-1/4" fender washer on the 1/4" x 2-1/4" elevator bolt on top of the floorboard.
- 5.3 Install 1/4" nut on bolt and draw bolt flush with bottom of floorboard. Remove nut.
- 5.4 Place cable pulley on top of 1/4" x 1-1/4" fender washer.
- 5.5 Place 1/4" lock washer on top of the cable pulley.
- 5.6 Install 1/4" nut on 1/4" bolt. See Photo # 5.6
- 5.7 Tighten nut.
- 5.8 Repeat Steps 5.1 through 5.7 for second cable pulley location.

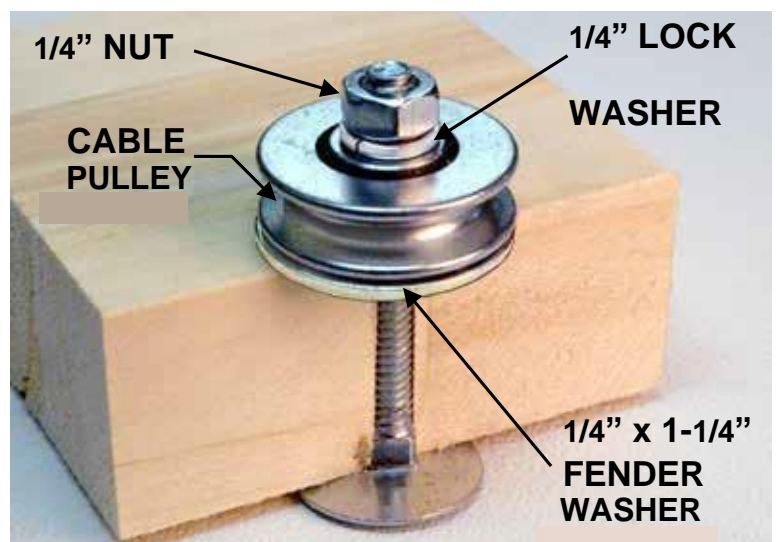

Photo # 5.6

Step Five

Continued

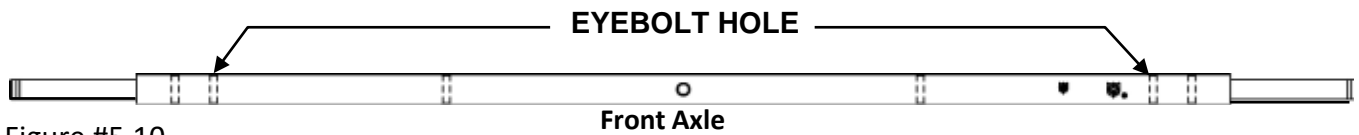

Figure #5.10

Axle Eyebolt Sub-Assembly

- 5.9 Install 10-24 nut on 10-24 x 2" eyebolt. Tighten the 10-24 nut to the end of threads on eyebolt.
- 5.10 Insert assembly through driver side of front axle at eyebolt location. See Figure # 5.10
- 5.11 Place a #10 lock washer on the bolt.
- 5.12 Install 10-24 nut on eyebolt assembly.
- 5.13 Tighten eyebolt assembly. See Photo # 5.13
- 5.14 Repeat Steps 5.9 through 5.13 for second axle eyebolt assembly.

Cable Adjuster Sub-Assembly

- 5.15 Install 8-32 nut on 8-32 x 1-5/8" eyebolt.
- 5.16 Insert eyebolt through any of the three holes of the inside of the cable adjuster and push through.
- 5.17 Place a #8 lock washer on 8-32 x 1-5/8" eyebolt.
- 5.18 Install 8-32 nut on # 8 lock washer. See Photo # 5.18
- 5.19 **Do not completely tighten assembly.** Further adjustments to occur in Step 11.
- 5.20 Repeat Steps 5.15 through 5.19 for second cable adjuster assembly.



Photo # 5.13



Photo #5.18



Step Five

Continued

Steering Cable Sub-Assembly

- 5.21 Determine the center point of the steering cable by folding the cable in half.
- 5.22 Insert the two loose ends of the steering cable through the lower hole of the steering wheel shaft located horizontally above the floorboard.
- 5.23 Pull the two loose cable ends through the hole until an eyelet is formed at the center point of steering cable.
- 5.24 Wrap one loose end of cable around shaft 180 degrees and thread through eyelet. See Figure # 5.24 – STEP ONE
- 5.25 Wrap other loose cable end in other direction around shaft 180 degrees from first cable, and thread through eyelet.
- 5.26 Pull both cable ends to tighten eyelet to secure cable.
- 5.27 Continue first cable around steering shaft to a minimum of 360 degrees (at least one complete wrap). See Figure# 5.27 – STEP TWO
- 5.28 Center steering wheel and temporarily clamp steering wheel from turning.

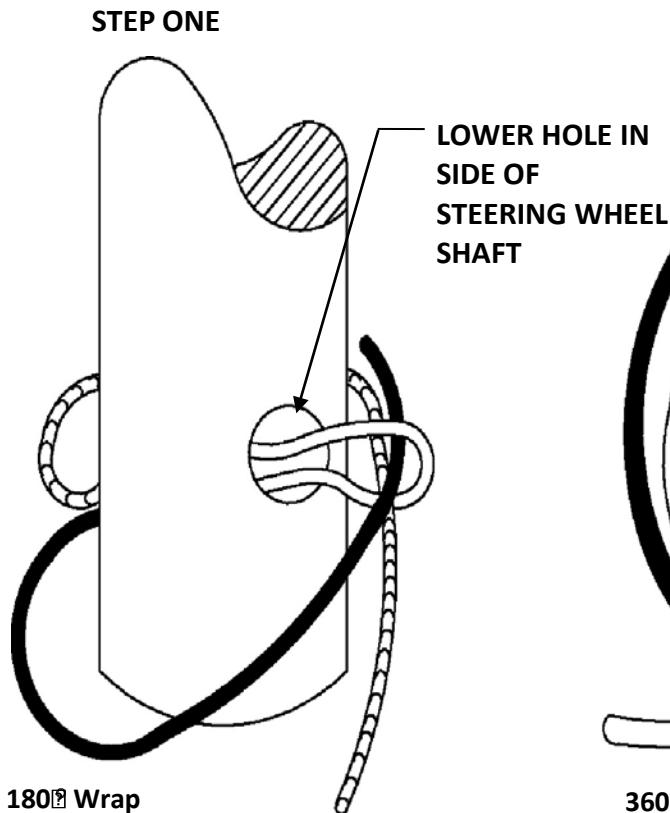

Figure #5.24

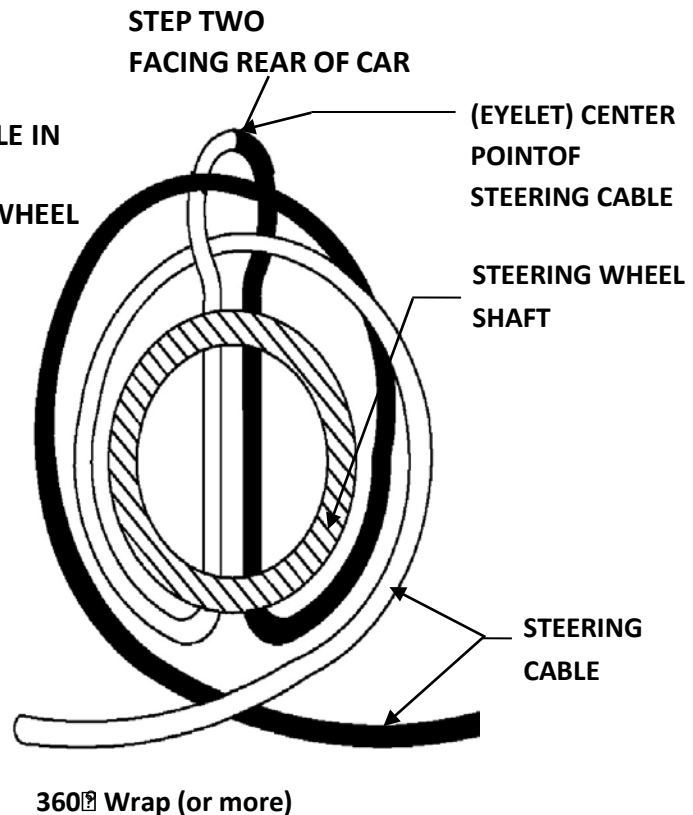

Figure #5.27



Step Five

Continued

Steering Cable Sub-Assembly Continued

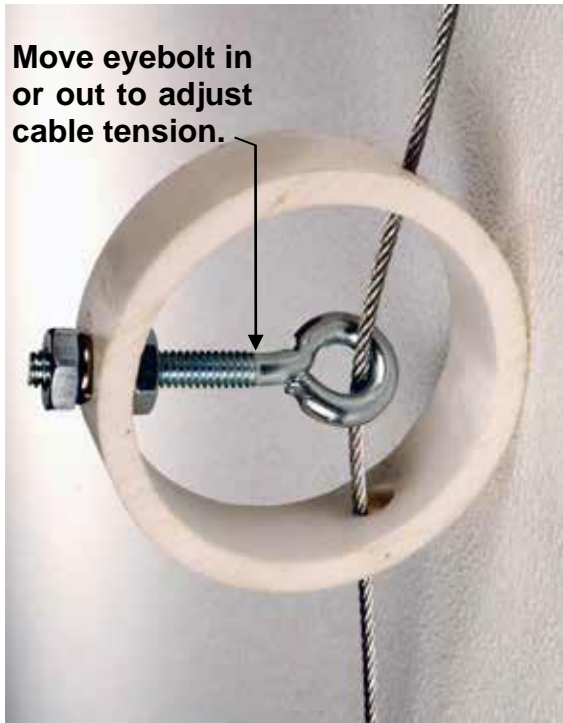

Photo #5.32

(Cable Adjuster Assembly)

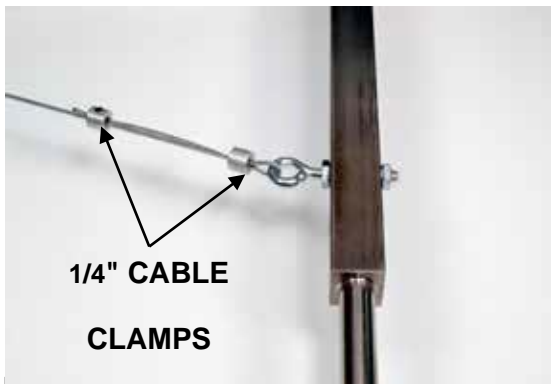

Photo #5.37

(Front Axle Eyebolt Assembly)

- 5.29 Thread one cable around steering pulley located on brake/steering mount.
- 5.30 Thread this cable through the outside of one of the two remaining holes in the cable adjuster and into the inside of the cable adjuster.
- 5.31 Thread cable through eyebolt inside cable adjuster.
- 5.32 Thread cable through the remaining hole in the cable adjuster. See Photo # 5.32
- 5.33 Thread one cable around cable pulley located on floorboard.
- 5.34 Slide two 1/4" cable clamps on cable end.
- 5.35 Thread cable through the front axle eyebolt assembly.
- 5.36 Insert loose end of cable back through both cable clamps.
- 5.37 Pull cables tight and tighten both cable clamps with a 5/64" Allen Wrench. Cable clamps can be placed next to each other or spread out. See Photo # 5.37



Step Five

Continued

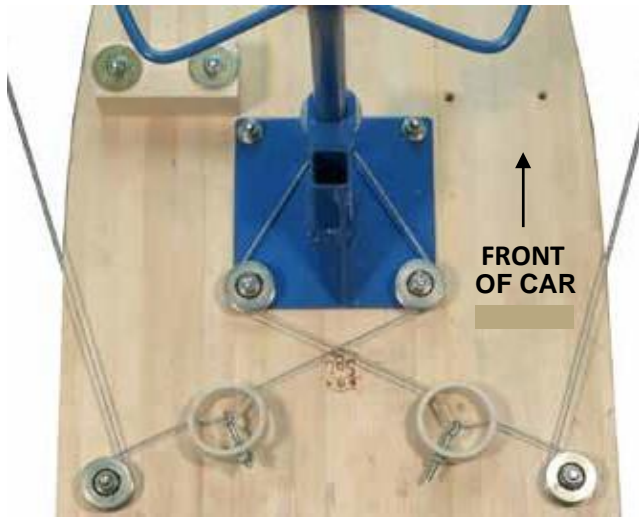

Photo #5.38(a)

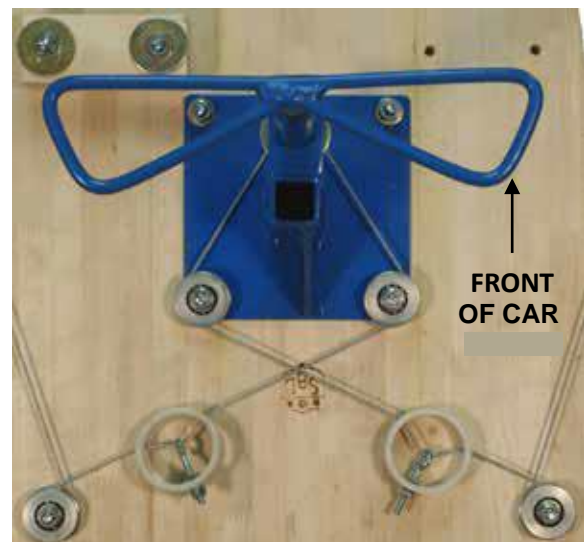

Photo #5.38(b)

Steering Cable Sub-Assembly Continued

- 5.38 Repeat steps 5.29 through 5.37 for the other cable. Refer to Photos # 5.38(a) and 5.38(b) for cable route.
- 5.39 Adjust steering cables by adjusting 8-32 x 1-5/8" eyebolts in cable adjuster assemblies.
- 5.40 Secure both cable adjusters by tightening both of the 8-32 nuts. Cable adjusters may be located anywhere along the cable. Remove temporary steering wheel clamp from Step 5.28.
- 5.41 Test by turning steering wheel to the right while seated facing the front of the car. The front axle must turn to the right.
- 5.42 Excess steering cable may extend past second 1/4" cable clamp and may be removed by cutting. To avoid cable fraying it is recommended that solder be applied to a 1/4" +/- on either side of the proposed cut prior to cutting. It is permitted to secure the loose ends of the cable with tape (provided by others).
- 5.43 Steering cable adjustment to occur in future Step 11.



Step Six **Angle Iron Installation. Required Items: Super Stock Stabilizer Bag, Angle Iron**

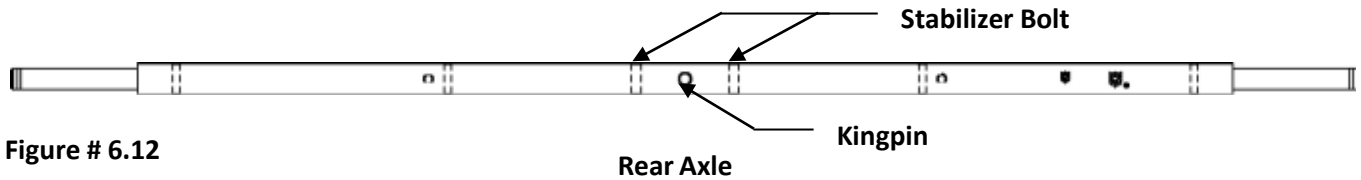
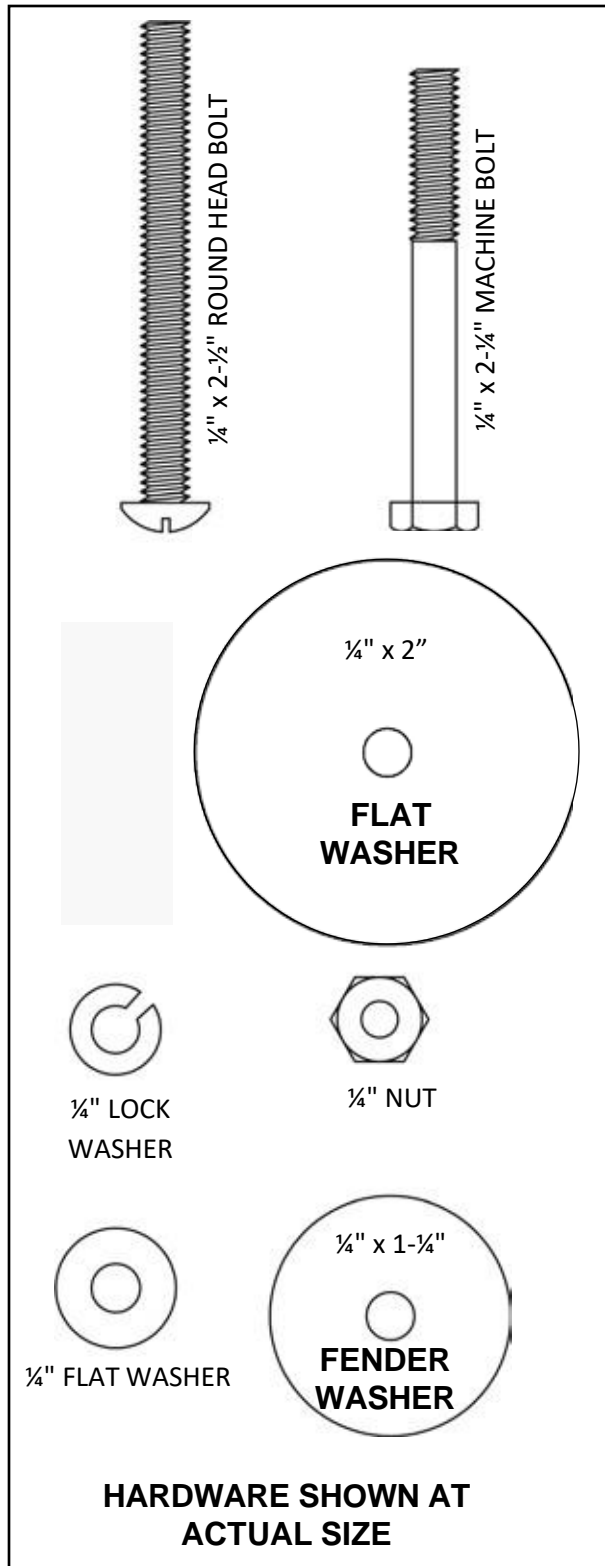

Figure # 6.12



Angle Iron Sub-Assembly at Rear Axle

- 6.1 Insert $\frac{1}{4}$ " x $2\text{-}\frac{1}{2}$ " round head bolt through back side of rear axle at a stabilizer bolt hole location. See Figure # 6.1 for stabilizer bolt hole locations. Round head bolt should be tight to the axle.
- 6.2 Place a $\frac{1}{4}$ " lock washer on $\frac{1}{4}$ " x $2\text{-}\frac{1}{2}$ " round head bolt.
- 6.3 Install $\frac{1}{4}$ " nut on bolt. Tighten nut.
- 6.4 Repeat Steps 6.1 through 6.3 for the second stabilizer bolt hole.
- 6.5 Install a second $\frac{1}{4}$ " nut on $\frac{1}{4}$ " x $2\text{-}\frac{1}{2}$ " round head bolt leaving a $1"$ +/- gap between the axle and the second $\frac{1}{4}$ " nut.
- 6.6 Place a $\frac{1}{4}$ " flat washer against the second $\frac{1}{4}$ " nut.
- 6.7 Repeat Steps 6.5 and 6.6 for second stabilizer bolt hole. See Photo # 6.7.
- 6.8 Slide the angle iron over the two bolts keeping the bottom leg flat against the SS rear axle plate. See Photo # 6.8
- 6.9 Place a $\frac{1}{4}$ " flat washer on $\frac{1}{4}$ " x $2\text{-}\frac{1}{2}$ " round head bolt.
- 6.10 Place $\frac{1}{4}$ " lock washer on bolt.
- 6.11 Install $\frac{1}{4}$ " nut on bolt. Do not completely tighten. See Photo # 6.11
- 6.12 Repeat Steps 6.9 through 6.11 for second stabilizer bolt hole.
- 6.13 The angle iron upright should be parallel with the rear axle. By maintaining the $1"$ +/- gap, the holes in the bottom leg of the angle iron should be aligned with those in the SS rear axle plate/floorboard.

Step Six

Continued



Photo #6.7

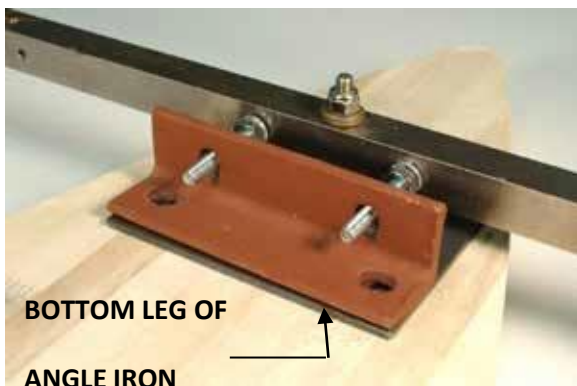

Photo #6.8

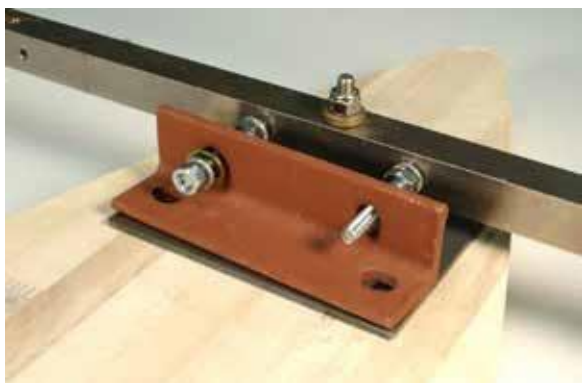

Photo #6.11



Photo #6.16

Angle Iron Sub-Assembly at Rear Axle Continued

- 6.14 Tighten both sets of the 1/4" nut assemblies on each side of the angle iron. See Photo # 6.14

Angle Iron Sub-Assembly at Floorboard

- 6.15 Place 1/4" x 2" flat washer on 1/4" x 2-1/4" machine bolt.
- 6.16 Insert bolt assembly through the bottom of floorboard at stabilizer/bushing location and press through the floorboard, SS rear axle plate and angle iron. See Photo #6.16
- 6.17 Place 1/4" flat washer on 1/4" x 2-1/4" machine bolt.
- 6.18 Place 1/4" lock washer on machine bolt.
- 6.19 Install 1/4" nut on machine bolt. See Photo #6.19
- 6.20 **Do not completely tighten.** Further adjustments to occur in future Step 11.
- 6.21 Repeat Steps 6.15 through 6.20 above for second stabilizer bolt hole.

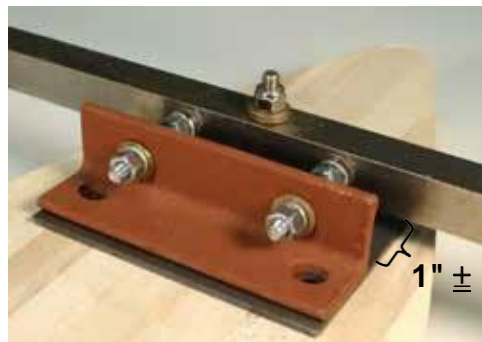

Photo #6.14



Photo #6.19

Step Seven

Brake Pad Installation. Required Items: Brake Pad Bag, Plunger, Tools

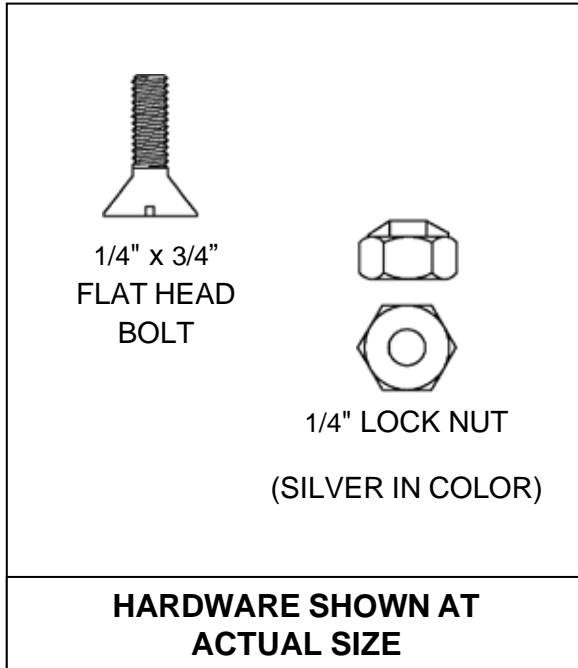

Brake Pad Installation

The brake pad may be installed to the plunger using both a 1/4" lock washer and 1/4" nut (provided by others) instead of the 1/4" lock nut.

- 7.1 Insert one 1/4" x 3/4" flat head bolt through each hole of the brake pad. Thick black side should be facing the ground. See Photo # 7.1
- 7.2 Align bolts in brake pad with holes in flat bottom of the plunger and insert.
- 7.3 Place a 1/4" lock nut (silver in color) on 1/4" x 3/4" flat head bolt (slotted or phillips head is acceptable).
- 7.4 Tighten assembly. It is recommended that approximately an eighth of the 1/4" x 3/4" flat head bolt (or three threads) is exposed. The 1/4" x 3/4" flat head bolt will be recessed in the bottom of the brake pad. See Photo # 7.4
- 7.5 Repeat Steps 7.1 through 7.4 for other three bolt locations.



Photo # 7.1
(Brake Pad)

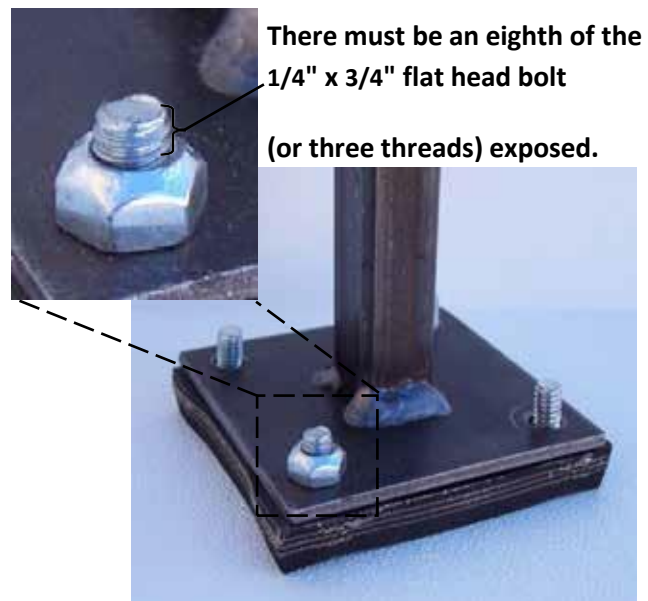
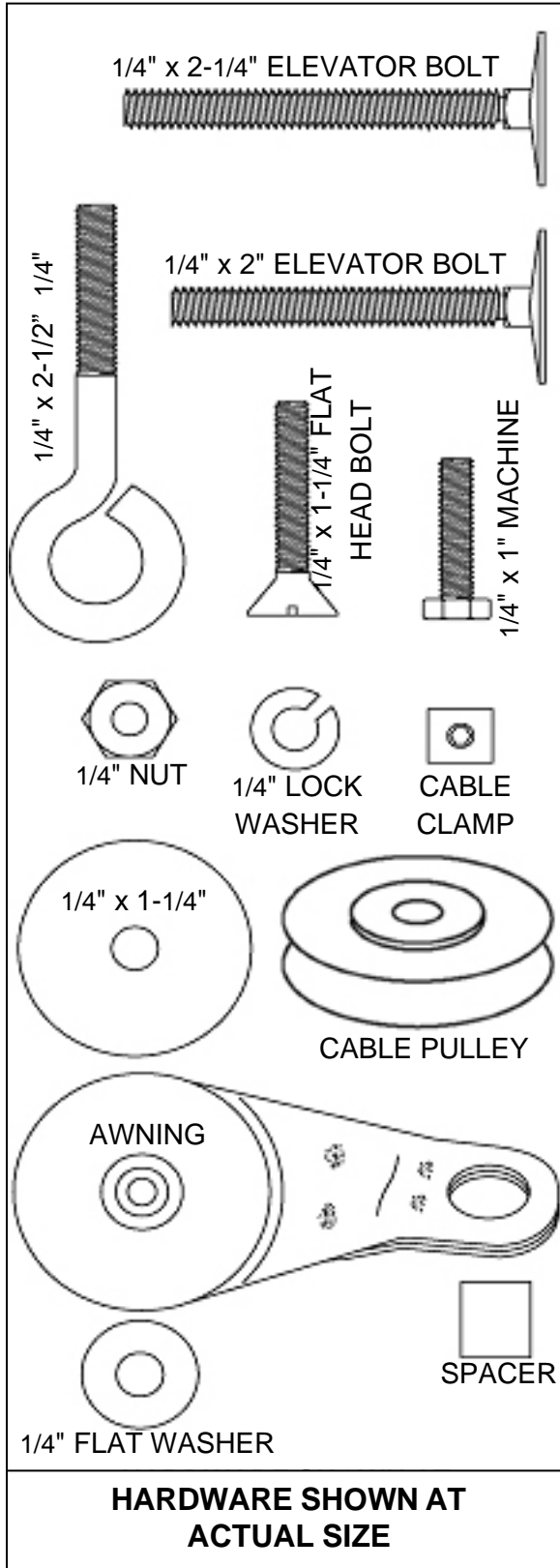

Photo # 7.4
Brake Pad/Plunger Assembly

Step Eight

Brake Installation. Required Items: Brake Bag, Floorboard, Brake Pad/Plunger Assembly from Step Seven, Brake Spring, Tape (provided by others), Tools



Brake Pedal Hinge Sub-Assembly

- 8.1 Align the four hinge holes with the brake pedal. Top of the wood brake pedal has rounded corners and the bottom is straight. The fifth hole located at the rounded corner is for brake pedal eyebolt installation.
- 8.2 Insert 1/4" x 1-1/4" flat head bolt through brake pedal and through one of the four hinge holes.
- 8.3 Install 1/4" lock washer on 1/4" x 1-1/4" flat head bolt.
- 8.4 Install 1/4" nut on 1/4" washer. **Do not completely tighten.** See Photo # 8.4
- 8.5 Repeat Steps 8.2 through 8.4 for other three bolts.
- 8.6 Tighten nuts until bolt heads are flush with face of brake pedal.



Photo # 8.4
(Partial image shown for clarity)

Step Eight

Continued

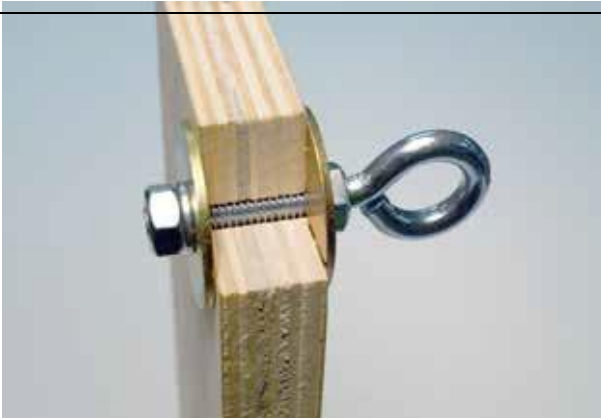

Photo # 8.12
(Eyebolt will face rear of car)

Brake pedal may be moved forward or back in brake Pedal/Brace Zone to accommodate a driver.

DO NOT ALTER THE BRAKE PEDAL

Brake Pedal Eyebolt Sub-Assembly

- 8.7 Install 1/4" nut on 1/4" x 2-1/2" eyebolt. Tighten nut to the end of threads on eyebolt.
- 8.8 Place 1/4" x 1-1/4" fender washer on the eyebolt.
- 8.9 Insert eyebolt assembly through the hole in the wood brake pedal on side opposite hinge.
- 8.10 Place 1/4" x 1-1/4" fender washer on the brake pedaleyebolt bolt assembly.
- 8.11 Install 1/4" lock washer on 1/4" x 1-1/4" fender washer.
- 8.12 Install 1/4" nut on bolt Tighten eyebolt assembly. See Photo # 8.12

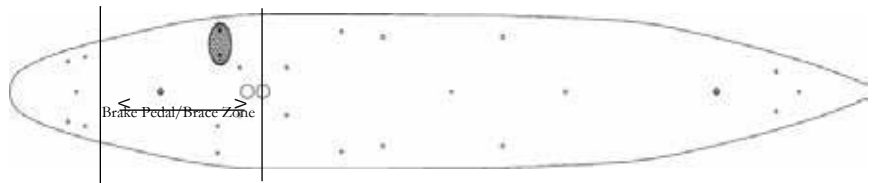

Brake Assembly Installation (Legend Area Highlighted)

Brake Pedal Hinge Sub-Assembly at Floorboard

- 8.13 Align the two outer holes of the brake pedal hinge with holes in floorboard at brake pedal location (center hole of hinge not used). See legend for location of holes.
- 8.14 Insert one 1/4" x 2" elevator bolt through the floorboard bottom at a brake pedal hole location and press through the floorboard and brake pedal hinge hole.
- 8.15 Place 1/4" lock washer on 1/4" x 2" elevator bolt.
- 8.16 Install 1/4" nut on 1/4" lock washer. Do not completely tighten.
- 8.17 Repeat Steps 8.13 through 8.16 for second bolt.
- 8.18 Tighten both nuts until bolts are drawn in flush with bottom of floorboard. See Photo # 8.18



Photo # 8.18

Step Eight Continued

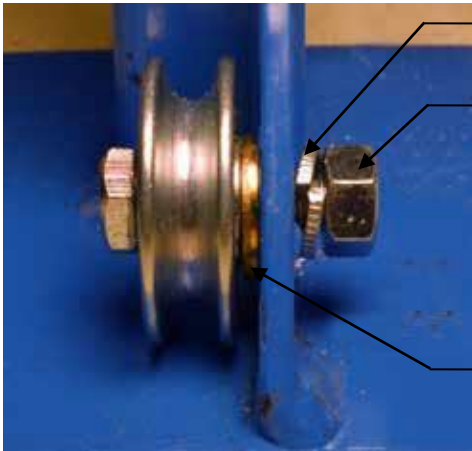

Photo #8.24

Cable Pulley Sub-Assembly at Brake/Steering Mount

- 8.19 Insert 1/4" x 1" machine bolt through cable pulley.
- 8.20 Place 1/4" flat washer on 1/4" x 1" machine bolt.
- 8.21 Insert 1/4" x 1" machine bolt with cable pulley and flat washer through hole in the left side of the vertical plate of the brake/steering mount.
- 8.22 Place 1/4" lock washer on the machine bolt assembly.
- 8.23 Install 1/4" nut on 1/4" lock washer.
- 8.24 Tighten assembly. Cable pulley shall spin freely. See Photo # 8.24



Photo #8.26

(Steering wheel and steering cables not shown for clarity)

Plunger Sub-Assembly

- 8.25 Install 1/4" nut on 1/4" x 2-1/2" eyebolt. Tighten nut to end of threads on eyebolt.
- 8.26 Insert square tube end of brake plunger assembly through bottom of floorboard at large round hole of brake/steering mount and push through top of brake/steering mount. See Photo # 8.26
- 8.27 Place brake spring on brake plunger.
- 8.28 Compress brake spring coil and insert eyebolt assembly through hole of plunger (eyebolt faces rear of car).
- 8.29 Place 1/4" lock washer on the eyebolt assembly.
- 8.30 Install 1/4" nut on eyebolt. See Photo # 8.30
- 8.31 Tighten eyebolt assembly.
- 8.32 Push assembly down several times to ensure smooth operation.



Photo #8.30

Step Eight

Continued

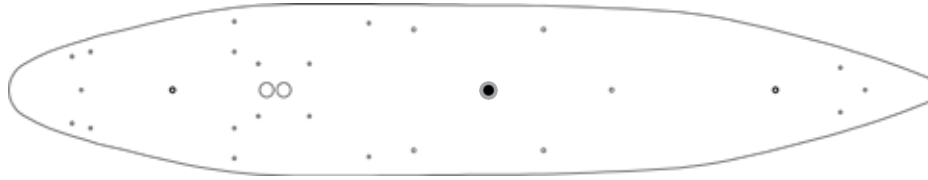

**Awning Pulley
Installation (Legend Area
Highlighted)**

Awning Pulley Sub-Assembly

- 8.33 Insert one $\frac{1}{4}$ " x 2- $\frac{1}{4}$ " elevator bolt through the floorboard bottom at awning pulley hole location. See legend for location of hole.
- 8.34 Place $\frac{1}{4}$ " x 1- $\frac{1}{4}$ " fender washer on the elevator bolt on top of the floorboard.
- 8.35 Install $\frac{1}{4}$ " nut. Tighten to draw elevator bolt flush with floorboard. Remove nut.
- 8.36 Place spacer on $\frac{1}{4}$ " x 1- $\frac{1}{4}$ " fender washer.
- 8.37 Place awning pulley hole on spacer.
- 8.38 Place $\frac{1}{4}$ " flat washer on awning pulley.
- 8.39 Place $\frac{1}{4}$ " lock washer on bolt.
- 8.40 Install $\frac{1}{4}$ " nut on $\frac{1}{4}$ " lock washer.
- 8.41 The awning pulley swings freely and should be pointed toward the front of the car. See Photo # 8.41
- 8.42 Tighten nut.

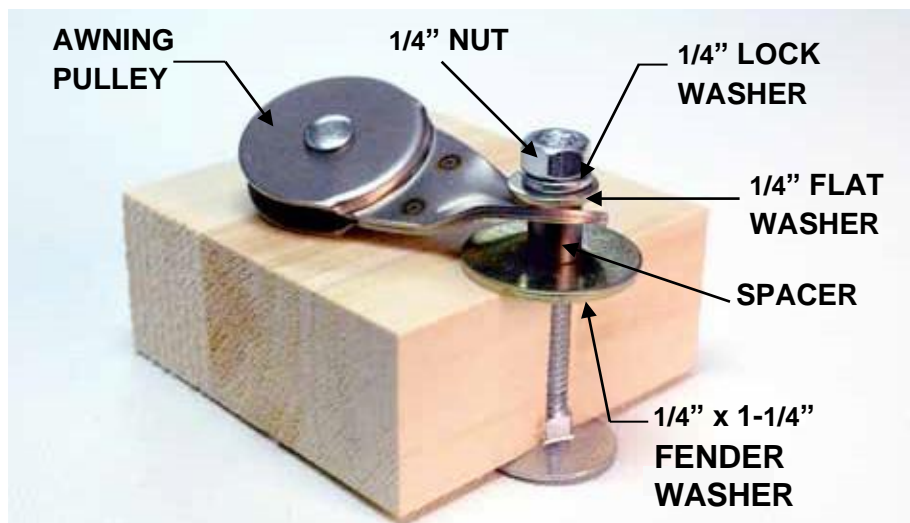

Photo #8.41

Step Eight Continued

Brake and steering cables may be double looped

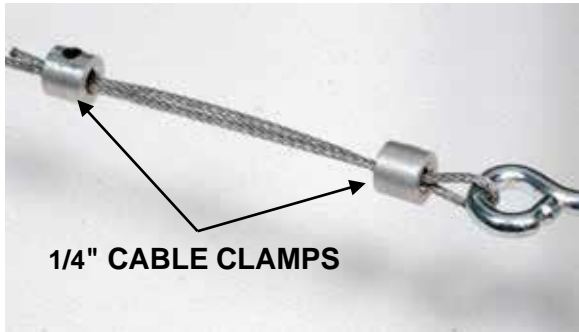

Photo #8.45



Photo #8.47

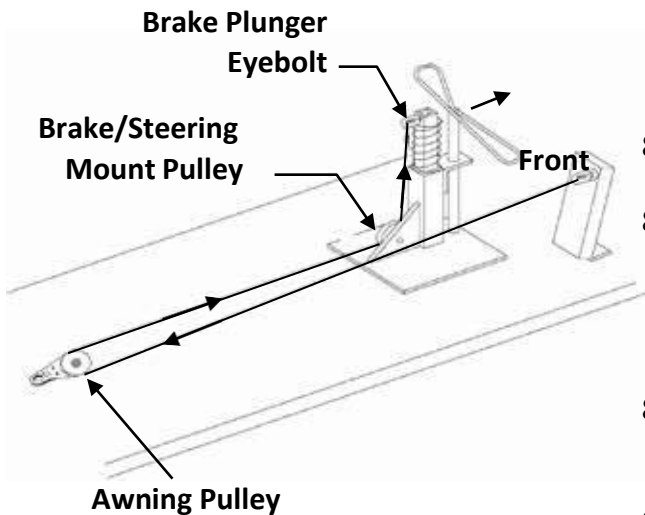

Figure #8.50

Brake Cable Sub-Assembly

- 8.43 Slide two cable clamps on one end of the brake cable.
- 8.44 Thread end of brake cable (approximately six inches) through the brake pedal eyebolt creating a loop around eyebolt.
- 8.45 Thread cable back through the two cable clamps. See Photo # 8.45
- 8.46 Tighten cable clamps with a 5/64" Allen Wrench.
- 8.47 Thread other end of brake cable through awning pulley and continue through cable pulley at brake/steering mount. See Photo # 8.47
- 8.48 Slide two cable clamps on the cable and continue the cable up through brake plunger eyebolt.
- 8.49 Insert loose end of the cable back through both cable clamps creating a loop around the eyebolt.
- 8.50 Pull loose end of cable tight and tighten cable clamps with a 5/64" Allen Wrench. See Figure # 8.50
- 8.51 Apply pressure to brake pedal and check for smooth operation of brake plunger. Lubrication of the plunger shaft and adjustment of the brake cable may be required. When brake is applied, brake plunger should extend sufficiently to the ground surface to stop the car.
- 8.52 Tighten all cable clamps securely.
- 8.53 Excess cable length may be removed by cutting. To avoid cable fraying it is recommended that solder be applied to a 1/4" +/- on either side of the proposed cut prior to cutting.
- 8.54 It is permitted to secure the loose ends of the cable with tape (provided by others).
- 8.55 Push the brake pedal several times to ensure proper operation.



Step Nine

Weight Bolt Installation. Required Items: Weight Bolt Bag, Floorboard, Weights (provided by others), Tools

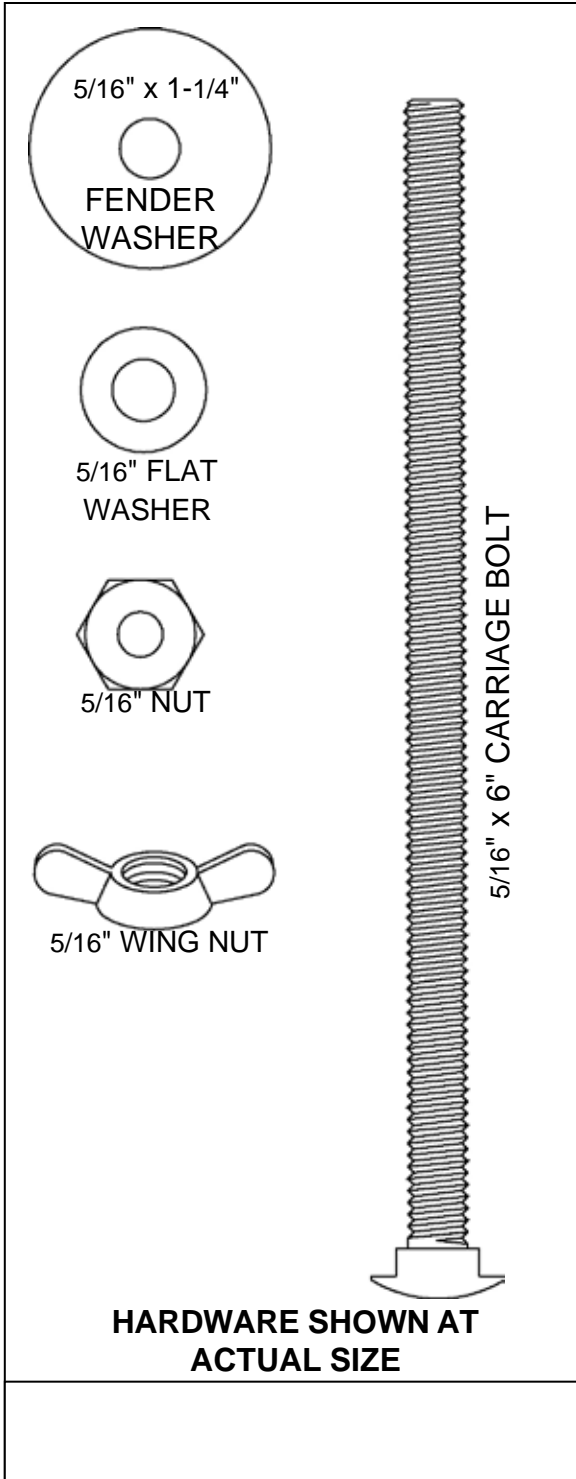

Weight Bolt Installation

- 9.1 Insert threaded end of 5/16" x 6" carriage bolt through the floorboard bottom at a weight hole location and press through the floorboard. See legend for location of holes.
- 9.2 Place a 5/16" flat washer on the 5/16" x 6" carriage bolt.
- 9.3 Install 5/16" nut on 5/16" flat washer.
- 9.4 Tighten bolt assembly.
- 9.5 Repeat Steps 9.1 through 9.4 for second bolt location.
- 9.6 These adjustable weight bolt assemblies are required.
- 9.7 See Tech Tip #1 – Optional Weights.

Step Nine

Continued

- 9.8 Place owner provided weights as needed on either, or both, of the 5/16" x 6" carriage bolts.
- 9.9 Place 5/16" x 1-1/4" fender washer on owner provided adjustable weight on both bolts.
- 9.10 Install 5/16" wing nut on 5/16" x 1-1/4" fender washer of both bolts. See Photo # 9.10
- 9.11 Tighten wing nuts. Note that 5/16" x 1-1/4" fender washer and 5/16" wing nut must be installed even if weight is not used.
- 9.12 See Tech Tip #1 – Optional Weights.

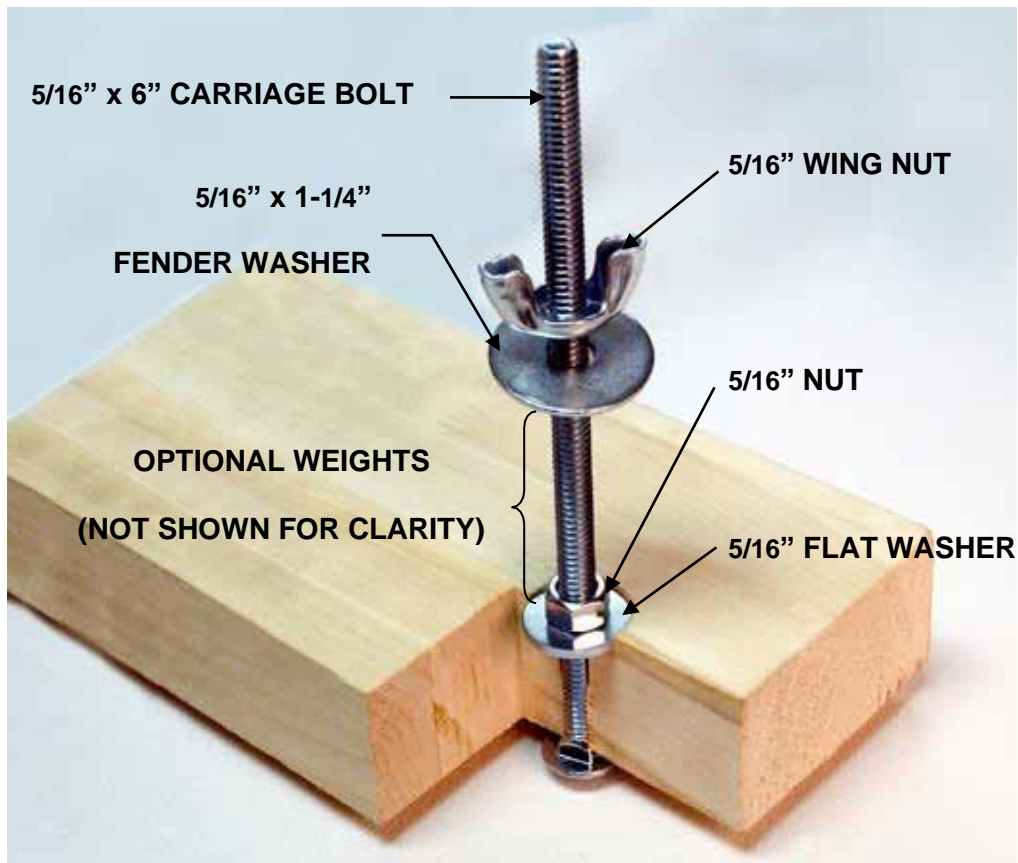
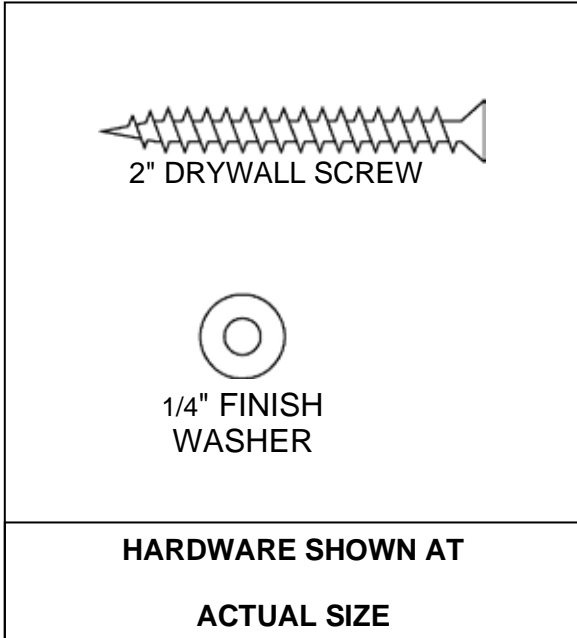

Photo # 9.10

Step Ten

Airfoil Installation. Required Items: Airfoil Bag, Airfoils, Floorboard Assembly, Tools



Front Axle Airfoil Installation

NOTE: Must cut airfoils to be used at front axle only(see Cut Here photo below).

Cut straight and flush with inside partition.

- 10.1 Slide airfoil over the front axle square stock. Airfoil must not extend into the spindle (round stock) portion of the axle. See Photo # 10.1
- 10.2 Place a 2" drywall screw through a 1/4" finish washer.
- 10.3 Insert 2" drywall screw with 1/4" finish washer through rear surface of axle square stock. Tighten assembly. Recommend hand driver only. See Photo # 10.3
- 10.4 Repeat Steps 10.2 through 10.3 for the second airfoil hole.
- 10.5 Repeat Steps 10.1 through 10.4 for second front axle airfoil.
- 10.6 No painting or covering the airfoils.

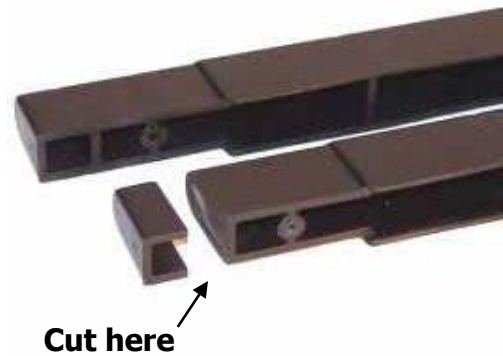

Photo #10.1

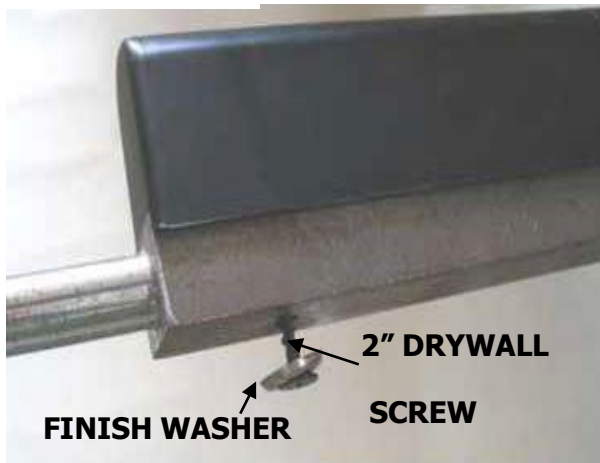
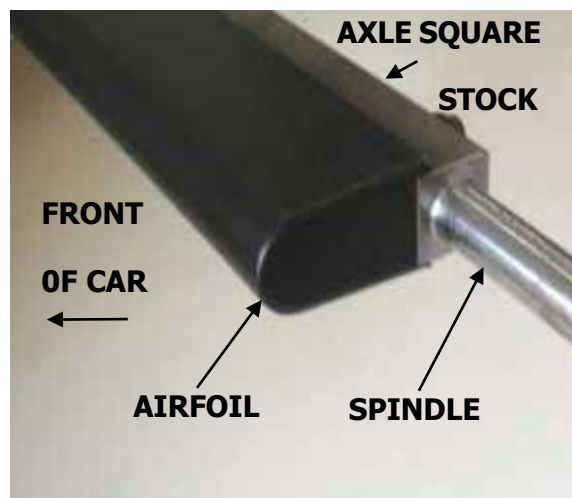

Photo #10.3



Step Ten

Continued

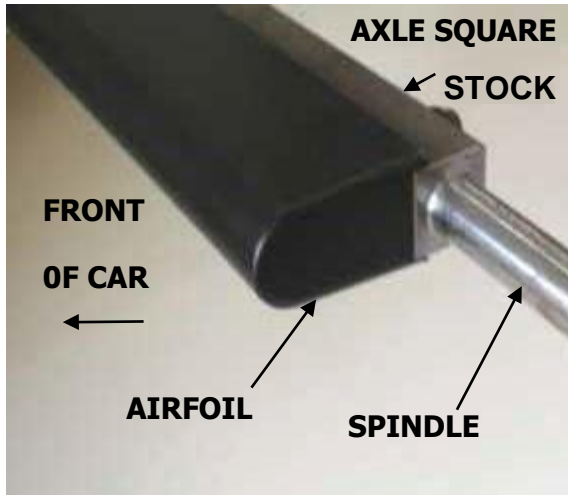

Photo #10.7

Rear Axle Airfoil Installation

- 10.7 Slide airfoil over the rear axle square stock. Airfoil must not extend into the spindle (round stock) portion of the axle. See Photo # 10.7
- 10.8 Place a 2" drywall screw through a 1/4" finish washer.
- 10.9 Insert 2" drywall screw with 1/4" finish washer through rear surface of axle square stock. Tighten assembly. Recommend hand drive only. See Photo # 10.9
- 10.10 Repeat Steps 10.7 through 10.9 for the second airfoil hole.
- 10.11 Repeat Steps 10.7 through 10.10 for second rear axle airfoil.
- 10.12 No painting or covering of the airfoils.



Photo #10.9



Step Eleven

Axle Alignment & Triangulation. Required Items: Tape Measure or Triangulation Tool (provided by others), Tools

Rear Axle Triangulation (Made easier by disconnecting brake pedal)



Photo #11.2

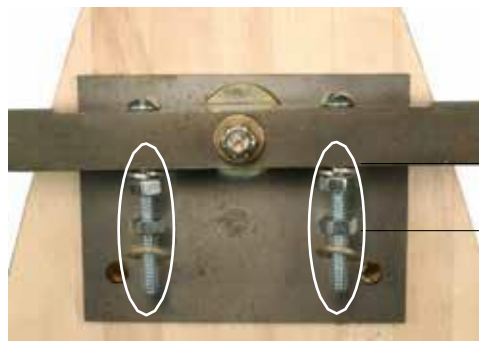

Photo #11.5

- 11.1 The rear axle will need to be aligned to ensure that the car tracks properly in a straight line. This is known as Triangulation. Contact your local Derby Director for other available methods and assistance.
- 11.2 Obtain a metal tape measure (other triangulation tools can be used in this step) to create a "Triangulation Tool." Drill a 1/4" hole near the end of the tape measure See Photo #11.2
- 11.3 Take off first nut only on front axle kingpin. Slide the 1/4" hole end of the tape measure over the front axle kingpin. Slide out the tape measure to establish Dimension B (PT#2 and PT#3) close to the end of the tape. Mark locations PT#2 and PT#3.
- 11.4 Semi-tighten the rear stabilizer assembly and adjust the rear axle until both dimensions are exactly the same between PT#1 and PT#2, and PT#1 and PT#3. See Photo # 11.4
- 11.5 If adjustments are needed loosen the stabilizer assembly as shown in photo 11.5 and make adjustments.
- 11.6 When both dimensions are equal, tighten the rear stabilizer assembly.
- 11.7 Check the measurement to ensure that it is equal.

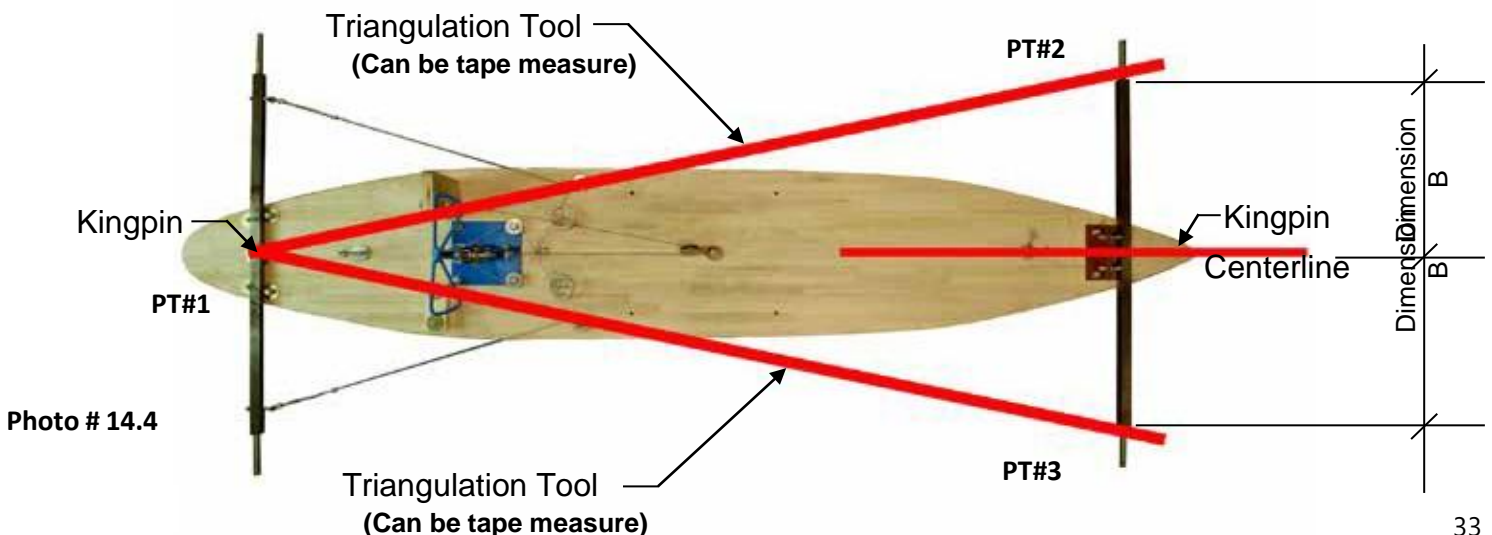

Photo # 14.4

Photo #11.4

Step Eleven

Continued

Front Axle Alignment

Move eyebolt in or out to adjust cable tension.



(Cable Adjuster Assembly)



Photo #11.14.

- 11.8 The front axle will need to be aligned to ensure that the steering wheel is properly centered to allow the car to properly track in a straight line. Contact your local DerbyDirector for other available methods and assistance.
- 11.9 Center the steering wheel. Measure from the back edge of the rear axle to the back edge of the front axle on both sides. Tighten or loosen the steering cables at the cable adjuster eyebolt until Dimension C is exactly the same on both sides. See Photo # 11.9(a) and Photo # 11.9(b)
- 11.10 Tighten nuts on both sides of the cable adjuster.
- 11.11 Check the measurement to ensure that it is equal. The steering cable should be tight; however, not so tight that it bows the front axle.
- 11.12 Make sure that the axle turns in the same direction as the steering wheel.
- 11.13 Tighten all parts of the steering assembly as shown in Step Five.
- 11.14 Excess steering cable may extend past second $\frac{1}{4}$ " cable clamp and may be removed by cutting. To avoid cable fraying it is recommended that you tape the ends (electrical tape or similar). The tape can cover a maximum of $\frac{3}{4}$ " of the cable and can be taped to the other cable. See Photo #11.14.

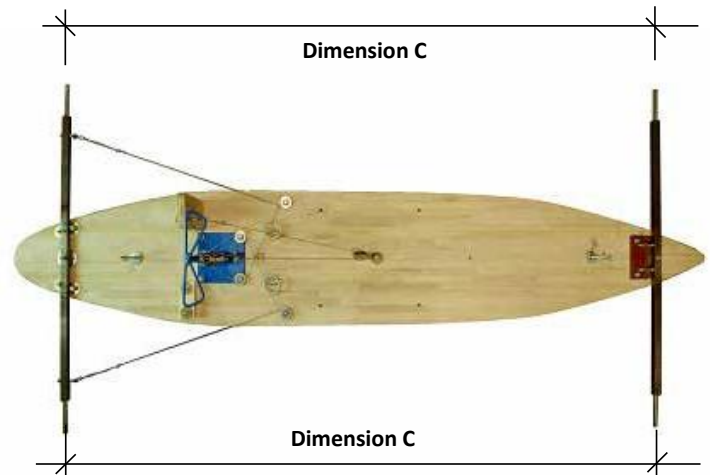
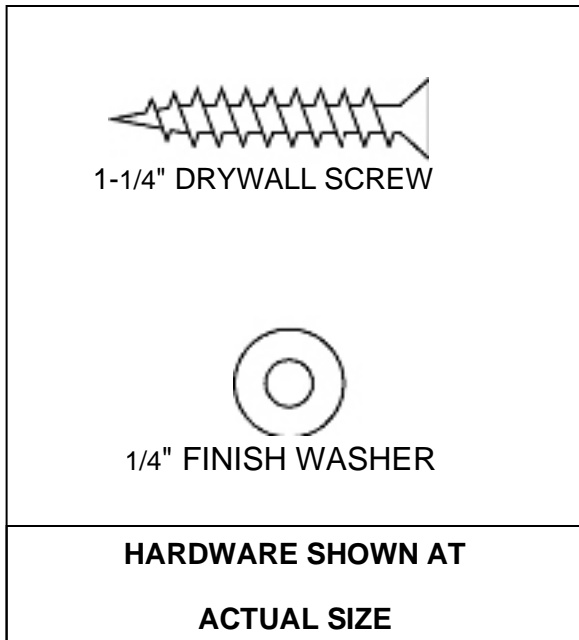

Photo #:

Step Twelve

Shell Installation. Required Items: Body Mounting Bag, Foam, Shell, Floorboard Assembly (completed to this point), Adhesive and Tape (provided by others), Tools



Front Foam Sub-Assembly

- 12.1 Determine the front center point of the shell cockpit and temporarily mark on top shell. This will establish the center of the foam.
- 12.2 Temporarily mark the center of the long dimension of the foam.
- 12.3 Apply adhesive (provided by others) to the surfaces per adhesive manufacturer's instructions.
- 12.4 Being sure to keep the top of the foam flush with the top of the shell, apply the foam to the front inner lip of the cockpit starting in the center and working outward on both sides. **Foam must be installed full dimension and may not be cut or altered.** See Photo # 12.4
- 12.5 Use tape (provided by others) to temporarily clamp foam until adhesive is set.
- 12.6 See Tech Tip 3 – Cockpit Foam.

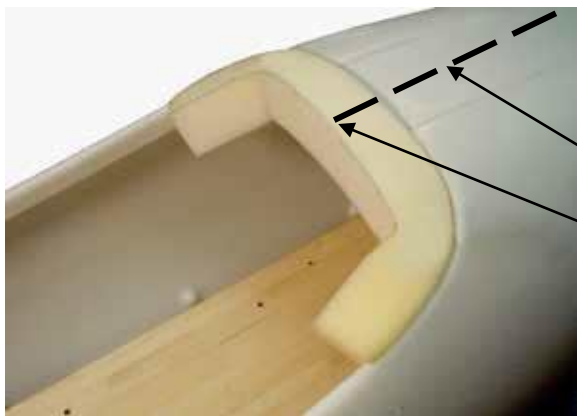

Photo # 12.4

Step Twelve Continued

NO ALTERING OF SCREW HOLES

The screw holes in the shell cannot be altered in any way.



Shell Installation
(Legend Area Highlighted – axles and other hardware not shown for clarity)

Shell Installation Sub-Assembly

- 12.7 Support floorboard off floor with sawhorses or two support boards wider than the floorboard width. Boards need to be the same thickness.
- 12.8 Lower shell over floorboard carefully slipping steering cables through slots at each side of the shell until shell is flush with bottom of floorboard.
- 12.9 Insert a 1-1/4" drywall screw through a 1/4" finish washer.
- 12.10 Insert the first screw/washer assembly through location "A" located at the front center of the car. Note that the hole for this location is not pre-drilled. See floorboard legend location "A".
- 12.11 Tighten the assembly until the nose of shell is flush to the front of the floorboard. No gap is permitted between shell and floorboard at the nose of the car. See Photo # 12.11
- 12.12 Adjust shell bottom to be flush with bottom of floorboard.
- 12.13 Insert another 1-1/4" drywall screw through a 1/4" finish washer.
- 12.14 Insert screw/washer assembly through a hole next to hole location "A".
- 12.15 Tighten screw/washer assembly until the shell is tight to the floorboard.
- 12.16 Repeat Steps 12.13 through 12.15 working your way from the front to the back (alternating sides) until all holes in the shell are filled with screw/washer assemblies.
- 12.17 Check for clearance at axles and steering cable openings; axle and steering cable openings may be trimmed to ensure clearance.

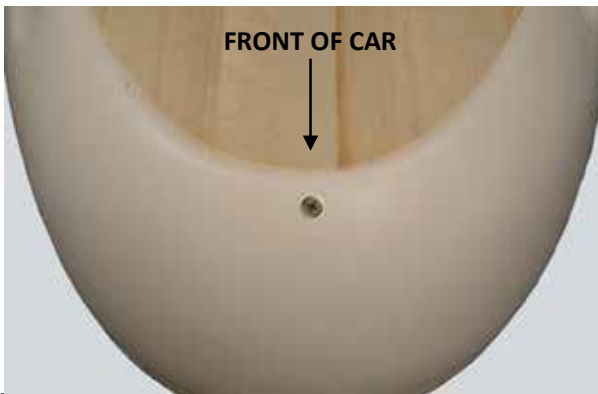

Photo # 12.11

(Bottom view of floorboard and shell)

Step Thirteen

Signage, Lettering & Decoration (Only for All-American Program NOT Education Program). Required Items: All-American Soap Box Derby Decals

- 13.1 Specific areas of the shell are restricted as to the signage, lettering and decoration permitted. See Photos # 13.1 Top and Side Views
- 13.2 No signage, lettering and/or decoration may cover any screw attachments or body openings.
- 13.3 Section A: All-American Soap Box Derby Number*
- This decal is only necessary to be put in place at the All-American Soap Box Derby World Championship.
- 13.4 Section B: Title/National Sponsor(s)*
- This decal (or these decals) must be put in place for all Local Races, Rally Races and for the All-American Soap Box Derby World Championship.
- 13.5 Section C: Local Race City Organization OR Rally Region
- This section is approximately thirty (30) inches wide and limited by the height of the shell.
- At the All-American Soap Box Derby World Championship, this section must include the participant's Local Race City Organization OR the Rally Region that the participant is representing. Lettering must be a minimum of 1-1/2" in height.
- Optional signage, lettering and decoration in this section may include the car's sponsor and/or the participant's name.

*Decals provided by the International Soap Box Derby, Inc. or your Local Race City Organization



Photo # 13.1 Top View

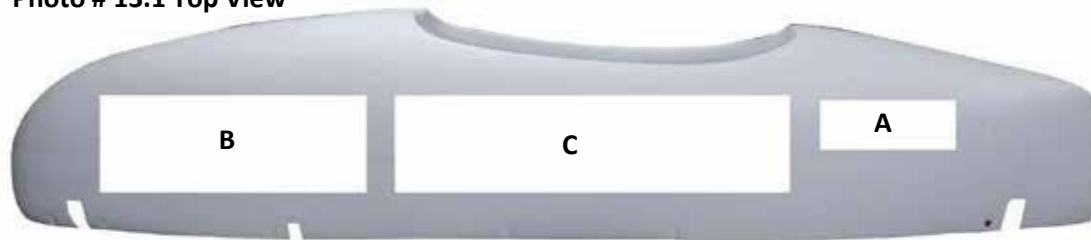

Photo # 13.1 Left Side View

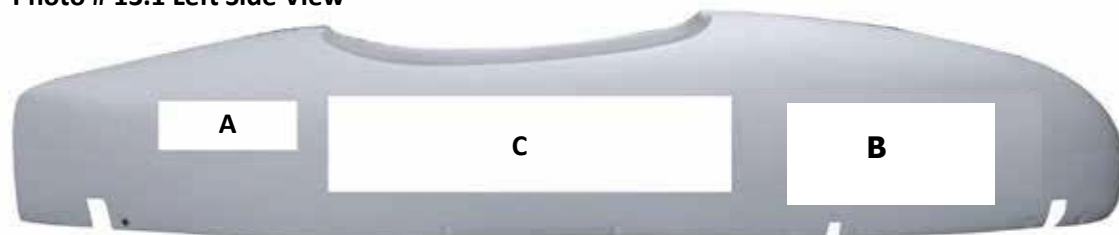
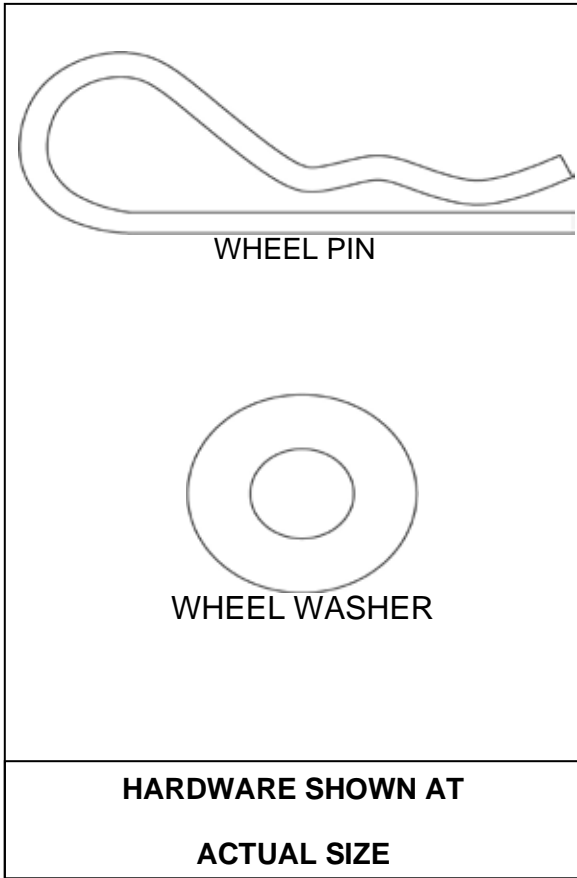

Photo # 13.1 Right Side View



Step Fourteen

Wheel Kit Installation. Required Items: Wheel Kit Bag, Z-Glas® Wheels (purchased separately), Tools



Wheel Kit Installation

- 14.1 Place a Z-Glas® wheel (purchased separately) on an axlespindle.
- 14.2 Place a wheel washer on the axle spindle with the Z-Glas® wheel.
- 14.3 Install wheel pin from front of axle through horizontal hole in axle spindle. See Photo # 14.3 Round portion of wheel pin shall face the front of the car.
- 14.4 Repeat Steps 14.1 through 14.3 for the other three wheels.
- 14.5 May use 0 to 2 washers per spindle.



Photo #14.3

(Wheel not shown for clarity)



Step Fifteen

Assembly Checklist

Carefully review the checklist below to ensure that you have completed the assembly of your car. The Installation Steps and Tech Tips are provided so that you may easily reference the work completed at each item identified.

- Steering Stop Installation (Step One)
- Foot Brace Installation (Step Two)
- Kingpin/Stabilizer Bushing Installation (Step Three)
- Steering Hardware Installation (Step Four)
- Steering Cable Installation (Step Five)
- Angle Iron Installation (Step Six)
- Brake Pad Installation (Step Seven)
- Brake Installation (Step Eight)
- Weight Bolt Installation (Step Nine)
- Airfoil Installation (Step Ten)
- Axle Alignment & Triangulation (Step Eleven)
- Shell Installation (Step Twelve)
- Signage, Lettering & Decoration (Step Thirteen)
- Wheel Kit Installation (Step Fourteen)
- Optional Weights (Tech Tip 1)
- Optional Finishes (Tech Tip 2)
- Cockpit Foam (Tech Tip 3)
- Alignment (Tech Tip 4)

Congratulations on completing your car. You are now ready to race!



Tech Tip #1

Optional Weights (Provided by Others) General Requirements

- 1.1 The car may be increased to the maximum weight of 240 pounds (including the driver, car and Z-Glas® wheels) by the addition of weights. The additional weight must be securely bolted through the floorboard and pass all requirements of the official inspection. There are two types of weight:
 - 1) Adjustable Weight
 - 2) Fixed Weight
- 1.2 Fixed and adjustable weights are available for purchase from the International Soap Box Derby, Inc.
- 1.3 Weight may consist of wood or metal materials. Weight in the form of angles, channels, tees or other structural shapes are not permitted. If bar bell type weights are used, the large center hole must be filled or a dowel rod must be used until the weight fits securely on the weight 5/16" bolt.
- 1.4 If 10 or less pounds of weight are used in a car, all of the weight must be adjustable.
- 1.5 If more than 10 pounds of weight is used in a car, a combination of fixed and adjustable weight is permitted. It's recommended that at least 10 pounds of the weight must be adjustable (Ex.: 3-two pound, 3-one pound, and 2-eight ounce or any other combination).
- 1.6 Weight may not be located between the original holes of the foot brace and the brake pedal back to the steering pulleys as shown in Photo #1.6.
- 1.7 A 1/8" clearance must be maintained between the weights, shell, axles, stabilizer assembly and the weight-free zone.

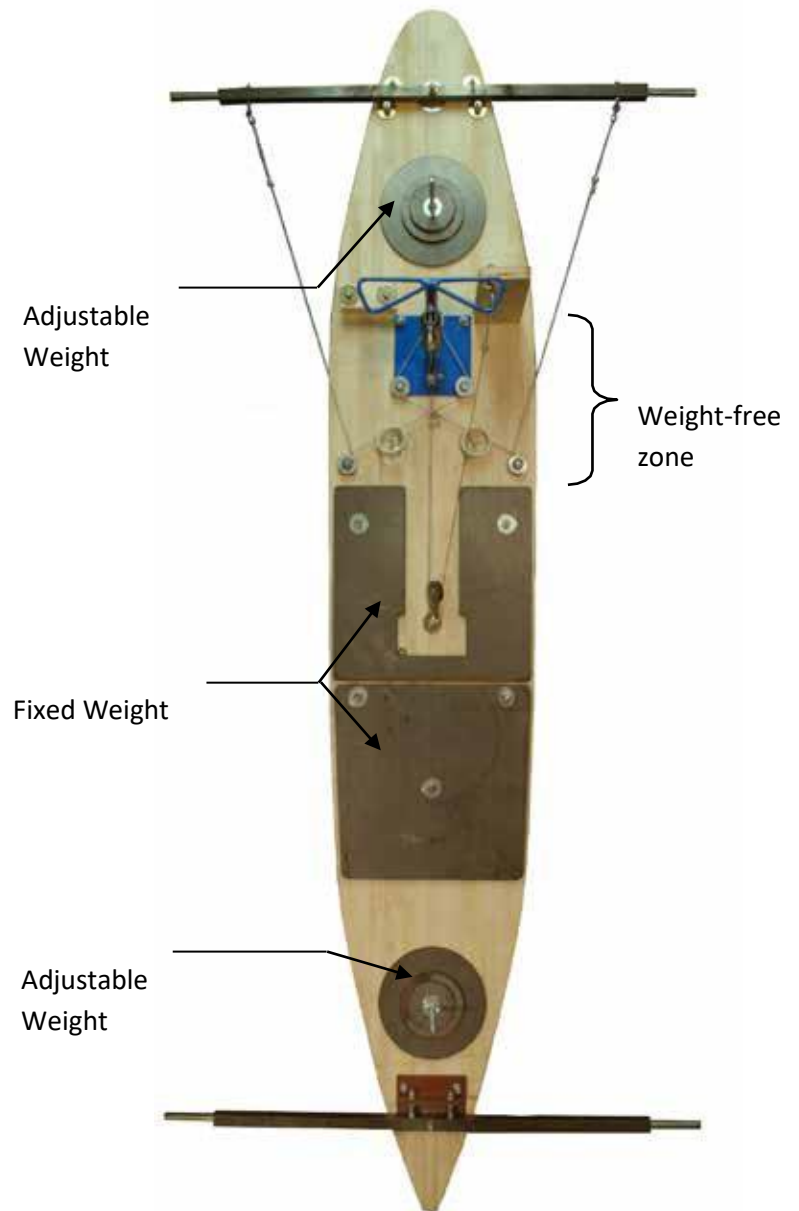

Photo #1.6



Tech Tip #1

Continued

- 1.8 All weights must be easily removable with adequate bolt clearance. Weights must not:
- 1) Disconnect or remove any hardware components
 - 2) Conceal any components
 - 3) Be permanently attached to the car
 - 4) Be threaded on the weight bolt
 - 5) Be poured into the car
 - 6) Touch the side or other components of the car
 - 7) Be chained to the car
 - 8) Be suspended. No cushion (sponge, rubber, springs, etc.) or other material may be used between the weights or the weight and the floorboard.
 - 9) Be cantilevered or bowed (must be flat).

- 1.9 Lead weight materials must be painted, and the weight of all weight material pieces must be clearly marked.

Adjustable Weights

- 1.10 Two locations are dedicated for the adjustable weight. The bolts for these locations were installed in Step Nine. These two bolts are the only location that adjustable weight will be placed. See floorboard legend. Adjustable weight height is limited only by the length of the bolt. The size of the adjustable weight is limited by the required 1/8" clearance to the shell, axles and stabilizer assembly and/or cannot exceed 12" lengthwise. See Photo #1.10

All weight must be placed inside the car on top of the floorboard.

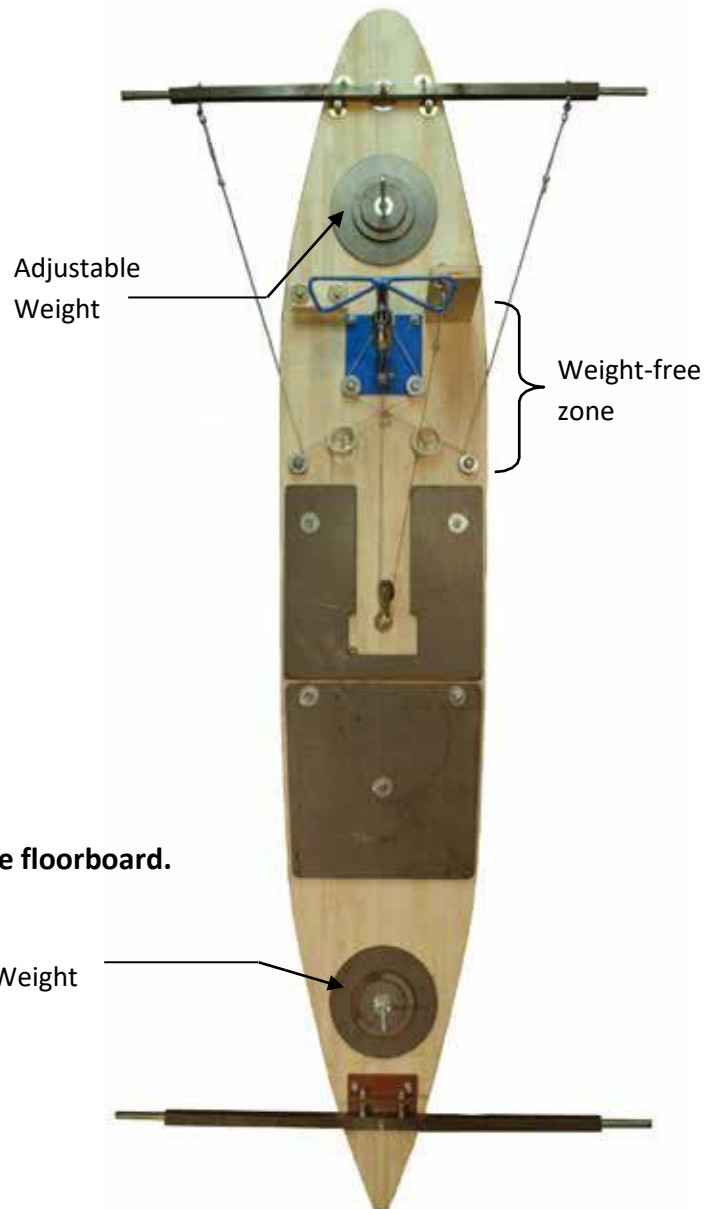
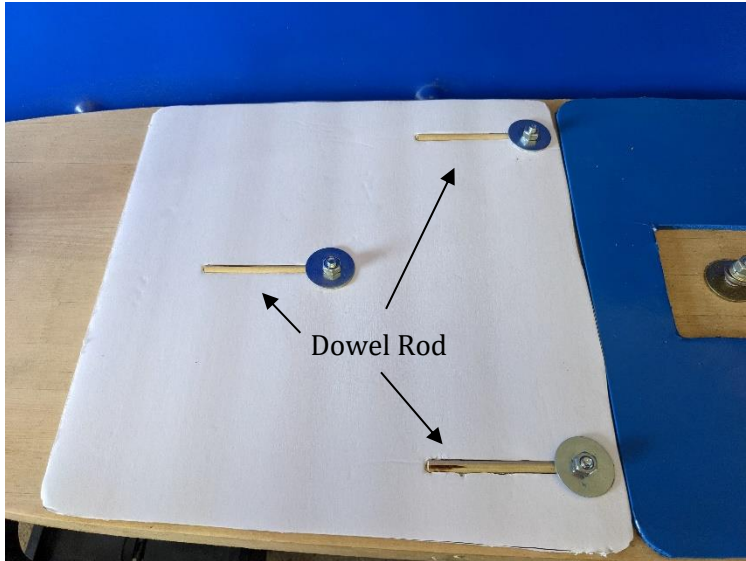

Photo #1.10

Tech Tip #1

Continued

Weights must have circular holes to secure them to the floorboard. Slotted weights are not permitted. All weights must stay stationary while racing. If you need to use slotted weights, the unused portion of the weight slots must be filled with standard weight materials to maintain a bolt hole opening only for the weight bolt. The weight bolt washer and nut must hold the assembly together. The photo below shows an example of filling the slot with a wooden dowel rod. The material must be underneath the washer to be held in place.



Tech Tip #1

Continued

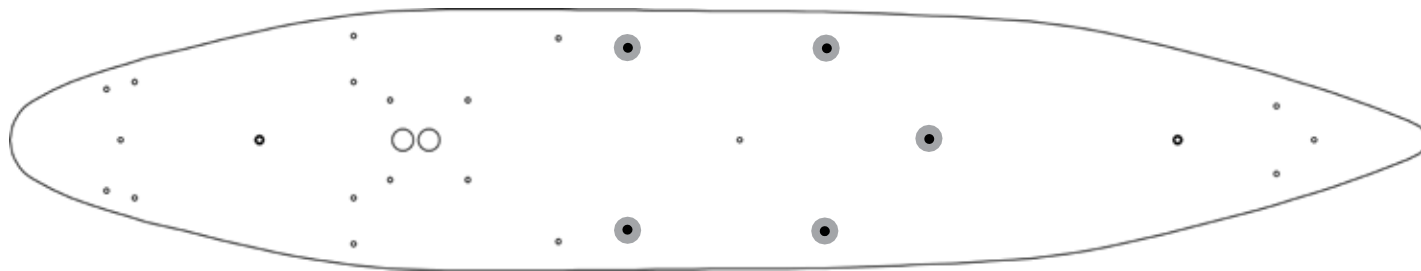

Fixed Weight Bolt Installation (Legend Area Highlighted)

- 1.11 Five bolt holes in the center/seat location of the floorboard are dedicated to fixed weight only. These five bolt areas are the only location that fixed weight may be anchored. See legend above for location of holes. Any combination of bolt locations may be used, but each weight must be secured by a minimum of one bolt. See Photo #1.11.
- 1.12 Fixed weight must not exceed a maximum height of 1-1/2" above the floorboard or exceed a 12" lengthwise dimension. Weight must be secured to prevent shifting or any type of movement with a 5/16" bolt, 5/16" x 1-1/4" fender washer and a 5/16" nut (provided by others).
- 1.13 No acorn nuts permitted
- 1.14 Added weight in the form of bars, plates or flat shapes are permitted but must not exceed 12" lengthwise, must stack evenly on each other in the car, and must not exceed a total height of 1-1/2". A minimum horizontal clearance of 1/8" must occur between the weights in the fixed weight area. Bolts under the driver must be trimmed flush to the top of the nut.
- 1.15 See Photo #1.15 for examples of adjustable and fixed

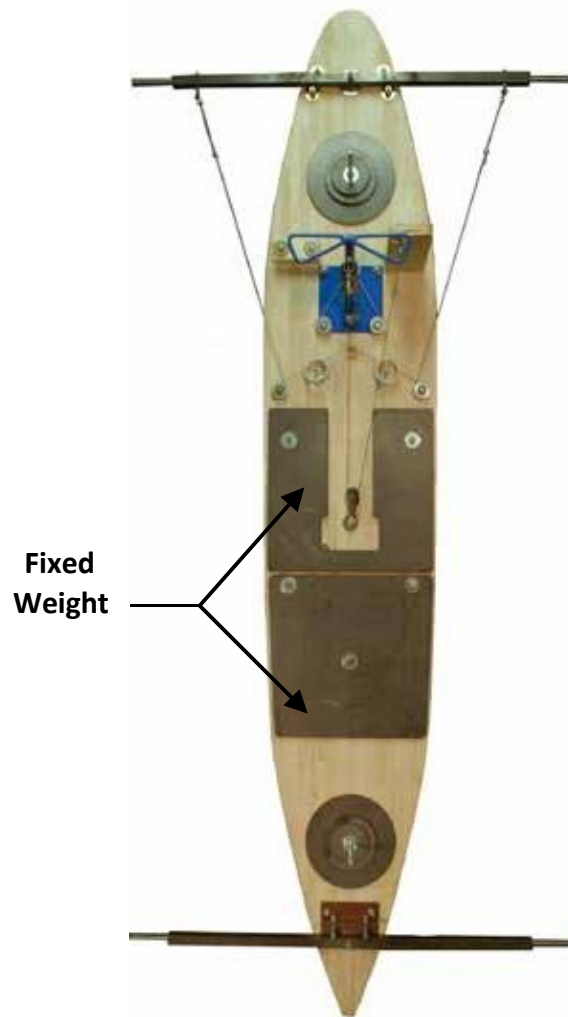

Photo #1.11.



IMPORTANT

After fixed weights are installed the bolts **MUST** be cut flush with the top of the nut to insure that a child will not get cut by the bolts.

Tech Tip #2

Optional Finishes (Provided by Others)

Floorboard

2.1 All Super Stock floorboards engraved with the Derby shield or burned with the SBD or SBD shield brands are the only acceptable floorboards. Photos 2.1, 2.2, 2.3 are 1999 or later. Particle floorboards



are no longer legal.

Photo #2.1

Photo #2.2

Photo #2.3

2.2 Tung oil and wax are the only acceptable products that may be applied to the floorboard. Tung Oil such as Minwax and Formby's are available on the open market. The Tung Oil and wax may be used on all surfaces of the floorboard. Please note that the machine marks on the sides of the floorboard shall remain. No finish build-up thickness shall occur.

2.3 Tung oil must not be applied to any hardware parts

Airfoils

2.4 No finish is required for the airfoils. The only optional finish material permitted is a thin coat of clear wax.

Shell

2.5 The only optional finish materials permitted, but not required, are:

1) Decorative permanent markers

The materials used in the shell manufacturing may cause permanent markers to not properly adhere; therefore, caution is advised when using this optional finish.

2) A thin coat of automotive-type wax

Caution is advised as some waxes contain colorings that may stain the material.

3) Paint

The exterior of the shell may be finished with paint. No paint finish is permitted inside the shell. Note that many paints may crack or may not properly bond to the Super Stock shell. Contact your local Derby Director for methods and assistance.

4) Self-adhesive vinyl materials

The entire exterior surface of the shell may be finished with solid sheets or decorative cutouts of self-adhesive vinyl material applied in a single layer.

Exceptions:

1) If sheet adhesive vinyl material is used, all International Soap Box Derby, Inc. sponsor decals must be placed over the vinyl material.

2) No vinyl is permitted on the inside of car.

3) No signage, lettering and/or decoration may cover any screw attachments (washers and screws).

Foam

2.6 Foam may be dyed using clothing dye.

Seam

2.7 The seam that is visible around the middle of the car can be covered with paint and primer products. Also, bodyfiller products such as Bondo are permitted to fill in the seam.



Tech Tip #3

Cockpit Foam

Shell-Cockpit Opening Rear Foam

- 3.1 An additional foam piece may be installed in addition to the required foam shown in Step 12.
- 3.2 Determine the rear center point of the shell cockpit and temporarily mark on top shell. This will establish the center of the foam.
- 3.3 Temporarily mark the center of the long dimension of the foam.
- 3.4 Apply adhesive (provided by others) to the surfaces per adhesive manufacturer's instructions.
- 3.5 Being sure to keep the top of the foam flush with the top of the shell, apply the foam to the inner lip of the cockpit starting in the center and working outward on both sides. Optional rear foam must be installed in full dimension and may not be cut or altered. See Photo #3.5.

Shell-Cockpit Opening Side Foam

- 3.6 Additional side foam may be optionally installed in addition to the required foam shown in Step 12.
- 3.7 Apply adhesive (provided by others) to the surfaces per adhesive manufacturer's instructions.
- 3.8 Being sure to keep the top of the foam flush with the top of the shell, apply the foam to the inner lip of the cockpit. The length of the optional side foam may be trimmed. The height and width of the optional side foam may not be cut or altered. See Figure #3.8
- 3.9 Adhesive (provided by others) may be applied at the end to end connections of the foam.

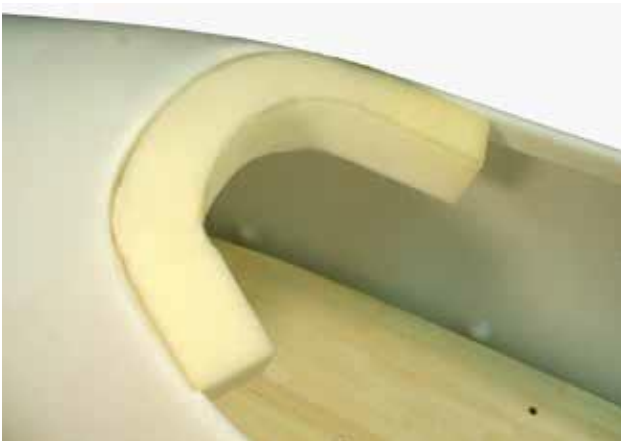

Photo #3.5

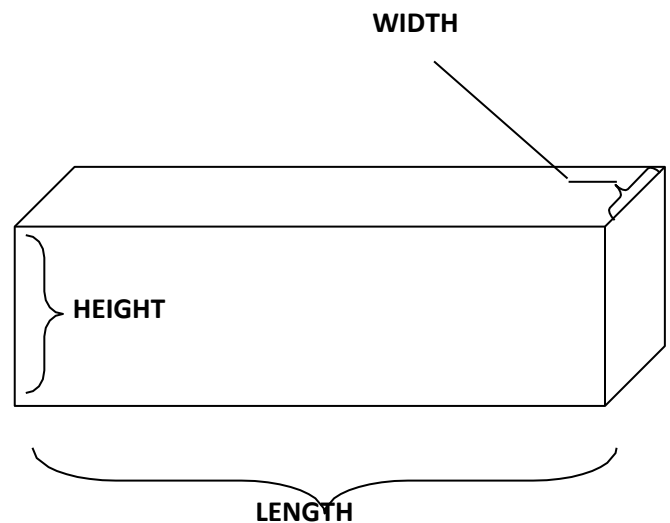

Figure #3.8
(Only the length of the optional side foam may be trimmed; the height and width may not be cut or altered.)



Tech Tip #3

Continued

Shell-Cockpit Rear Lip

3.10 A portion of the shell's inner lip may be removed in an area starting 6-1/2" behind the front center of the cockpit opening continuing to the rear of the opening. A minimum of 1/4" of the lip must remain intact. See Figure #3.10 and Photo # 3.10.

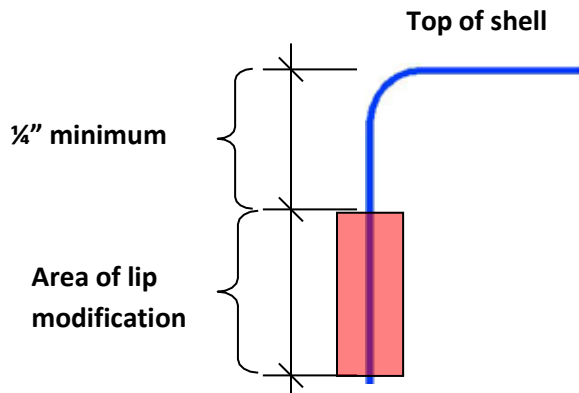

Figure #3.10

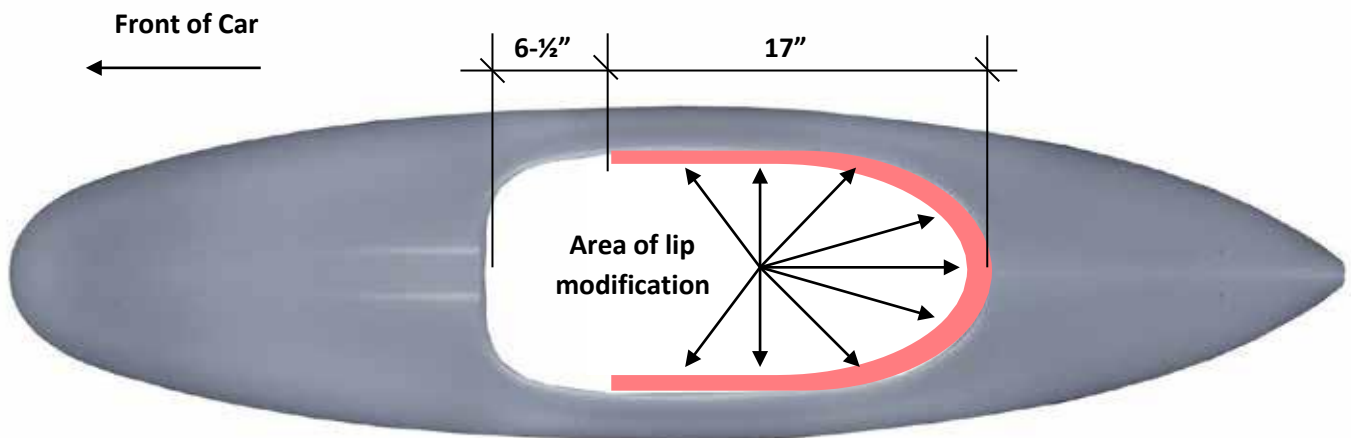

Photo #3.10



Tech Tip #4

Alignment

Axle Alignment – Cross Bind Adjustment

- 4.1 Cross bind adjustment is used to create a parallel horizontal plane between the front and rear axles. A single shim placement at either the front or the rear axle, not both, may be installed to eliminate cross bind between the two axles. This procedure is offered as guidance but is not the only method available. Contact your local Derby Director for other available methods and assistance. See Figure #4.1.
- 4.2 Elevate the floorboard and view the horizontal alignment of the front and rear axles from one end of the car. Determine if shimming is needed based on whether or not the axles are parallel.
- 4.3 The permitted shim must be a single, complete, uncut, feeler gauge (set available at any automotive store). Shims are available in thickness starting at one thousandth of an inch (.001). **Only one shim may be used in a car.** See Photo #4.3.
- 4.4 Install the single shim at the kingpin bolt assembly between floorboard and a washer or between two washers, all occurring below the axle bottom and at only one axle kingpin location. Small nails may be used to hold one or both ends of the feeler gauge in place. See Photo #4.4.
- 4.5 Tighten all parts of the kingpin assembly as shown in Step 3.



Photo #4.3 (Feeler Gauge Set)



Photo #4.4

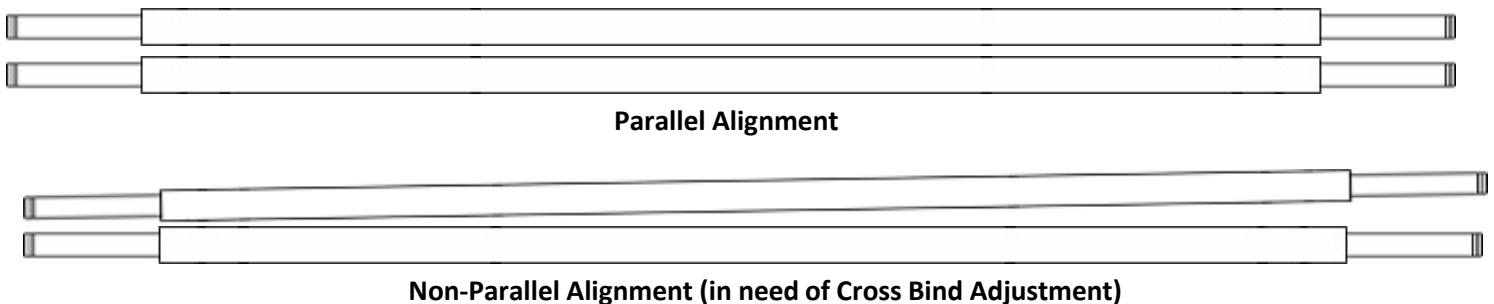

Figure #4.1



Tech Tip #4

Continued

Axle Alignment – Spindling

4.6 Spindling is an optional adjustment of the spindle (round portion) of the axle to gain Toe or Camber Alignment.

This is an advanced procedure that requires specialized tools, knowledge, patience and extreme caution to ensure that the axles are not modified and declared disqualified. Contact your local Derby Director for methods and assistance.

See Figure #4.2 and Figure #4.3.

Top View of Axle showing Toe Alignment (Distorted for Clarity)

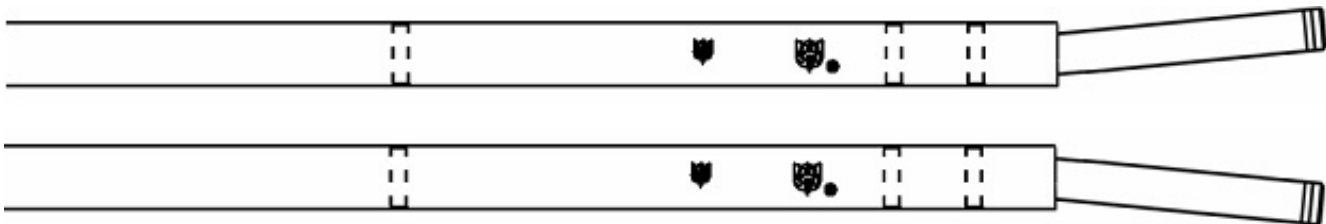

Figure #4.2

(Partial Front Axle (with all hardware removed) shown as an example only. This figure can be used for both front and rear axles.)

Side View of Axle showing Camber Alignment (Distorted for Clarity)

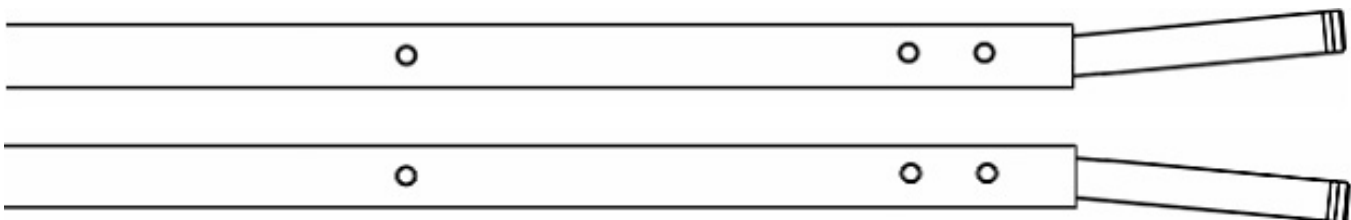

Figure #4.3

(Partial Front Axle (with all hardware removed) shown as an example only. This figure can be used for both front and rear axles.)

